

*O&M Manual
Revision 5.0*

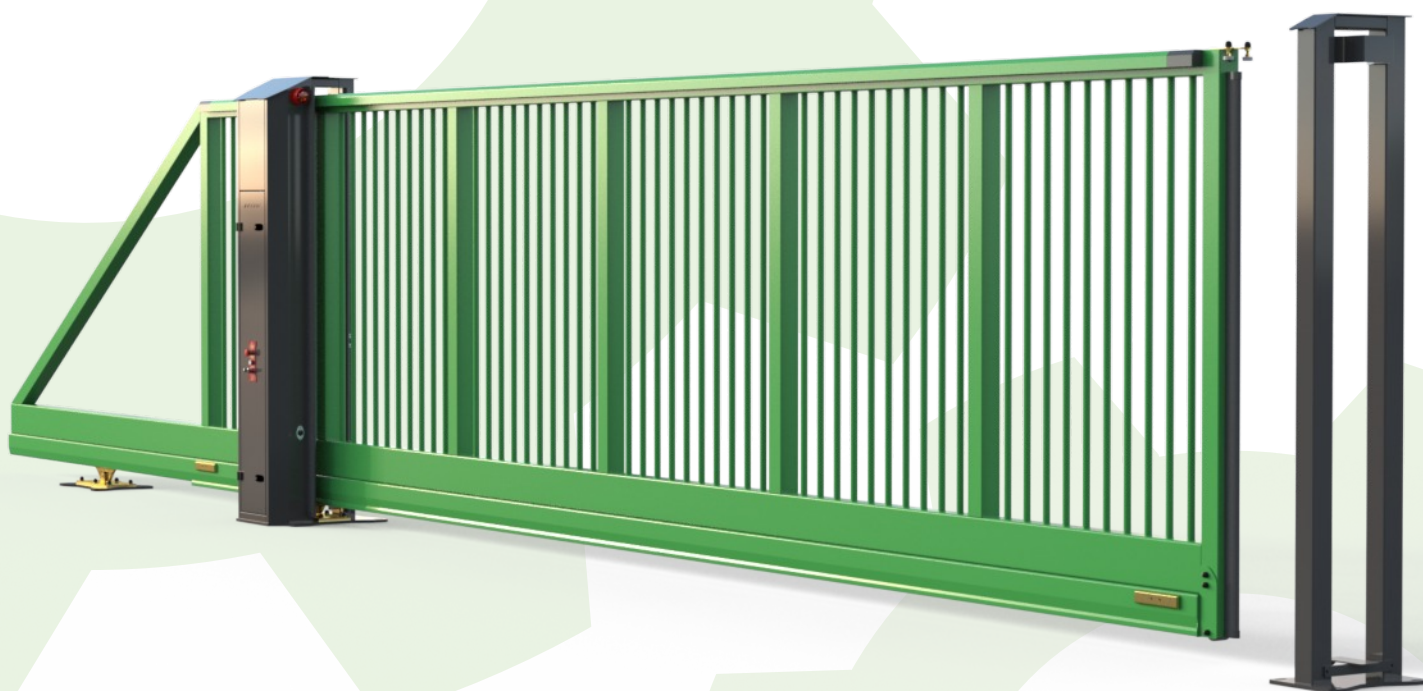

D5800
Automatic cantilever sliding gate



| | |
|-------------------------------------|---------|
| 1. Inductions and warnings | Page 03 |
| 2. Delivery, Movement and transport | Page 04 |
| 3. Lifting and handling | Page 05 |
| 4. General layout | Page 06 |
| 5. Installation | Page 07 |
| 6. Control Panel Layout | Page 19 |
| 7. Connection Diagrams | Page 21 |
| 8. Front Panel Layout / Usage | Page 25 |
| 9. Initial Start Up / Slow Down | Page 26 |
| 10. Initial Set-up Walk Through | Page 27 |
| 11. Positions Explained | Page 29 |
| 12. Auto Close Explained | Page 30 |
| 13. Motor / Speed Settings | Page 31 |
| 14. Timers / Slow Down Settings | Page 27 |
| 15. Manual Release | Page 33 |
| 16. Error Codes | Page 34 |
| 17. Trouble Shooting | Page 36 |
| 18. Maintenance | Page 37 |
| 19. Service Log | Page 38 |
| 20. Commissioning Certificate | Page 39 |
| 21. Declaration Of Conformity | Page 40 |
| 22. Technical Data | Page 41 |

This equipment is part of a large range of traffic flow products. They are designed to be easy to install, as all settings and internal wiring have been completed in our factory. Any of the instructions in this manual should only be carried out by a qualified service engineer or a competent person.

The Gates are ready to bolt down, connect to a single phase power supply and have any pre-cut loops wired into them (Please note that loop detectors are sold separately). The steps must be completed before the power is turned on to prevent accidents.

The following information is a guide only, and whilst we have made every effort to be accurate and correct there may be printing errors which we cannot be held responsible for.

With a correct installation you can expect to enjoy many years of reliable service from this product, we do however recommend that the product has a bi-annual service carried out by a qualified engineer. Please contact our service department to obtain a quote. As we manufacture the products we are best suited to care for your equipment.

Important Safety Notice



Automatic gates are designed to Control the flow of vehicular traffic only. It can be dangerous to allow the passage of pedestrians and any other self-powered animal or device to utilise this method of access without appropriate warnings and or signage.

It may be necessary for the end user of this product to provide an alternative, safe method of access to cater for the previously mentioned categories.

The end user should fit all necessary signage and warning notices to either side of the gate, which should be visible and clear from all directions of approach.

The product that was shipped to you was designed with a control program to protect all categories from harm or affect this however is only a safety precaution and should not be modified or tampered with by any unauthorised person not sanctioned by the manufacturer.

Please sign and date below to say that you have read and understood this notice before ANY installation work:

/ /20

Information on using this manual



- ✍ Read all information thoroughly
- ✍ Pay attention to all safety advice
- ✍ Be aware of the symbols (shown above right and above left) as they have different meanings. One is an information symbol, the other a warning.
- ✍ There are many artists impressions of the product in this manual you should refer to the images as a guide only. **Professional CAD** drawings should be used as a reference drawing and nothing else. As before every effort has been made to be 100% accurate in this manual but we cannot make any guarantees.
- ✍ As we constantly innovate our products we may change the quoted spec and any other details that have been documented in this manual so you should always refer to the supplier to see if the manual that was shipped with your product is the latest edition.
- ✍ As with all electrical installations you should use a qualified electrician and obey all of the latest laws and regulations.
- ✍ Be sure to fill out and complete **ALL** paperwork where instructed as this manual is the equipments log book and maintenance manual.

The "Warnings" leaflet and "Instruction booklet" supplied with this product should be read carefully as they provide important information about safety, installation, use and maintenance.

Scrap packing materials (plastic, cardboard, polystyrene etc) according to the provisions set out by current standards. Keep nylon or polystyrene bags out of children's reach.

Keep the instructions together with the technical brochure for future reference.

This product was exclusively designed and manufactured for the use specified in the present documentation. Any other use not specified in this documentation could damage the product and be dangerous.

The Company declines all responsibility for any consequences resulting from improper use of the product, or use which is different from that expected and specified in the present documentation.

Do not install the product in explosive atmosphere.

The construction components of this product must comply with the following European Directives: 2014/30/EU, 2014/35/EU, 2023/1230/EU (2006/42/EC) and subsequent amendments. As for all non-EEC countries, the above mentioned standards as well as the current national standards should be respected in order to achieve a good safety level.

The Company declines all responsibility for any consequences resulting from failure to observe Good Technical Practice when constructing closing structures (door, gates etc.), as well as from any deformation which might occur during use.

The installation must comply with the provisions set out by the following European Directives: 2014/30/EU, 2014/35/EU, 2023/1230/EU (2006/42/EC) and subsequent amendments.

Disconnect the electrical power supply before carrying out any work on the installation. Also disconnect any buffer batteries, if fitted.

Fit an omnipolar or magnetothermal switch on the mains power supply, having a contact opening distance equal to or greater than 3mm.

Check that a differential switch with a 0.03A threshold is fitted just before the power supply mains.

Check that earthing is carried out correctly: connect all metal parts for closure (doors, gates etc.) and all system components provided with an earth terminal.

Fit all the safety devices (photocells, electric edges etc.) which are needed to protect the area from any danger caused by squashing, conveying and shearing, according to and in compliance with the applicable directives and technical standards.

This article describes how your equipment will be delivered to you, specifications on the transportation used and advice including health & safety on movement of the equipment.



The manufacturer will use a qualified transport company to deliver the product conforming to the necessary regulations as detailed below:

- ✘ All drivers are qualified
- ✘ All drivers are tested once yearly (If applicable)
- ✘ All drivers carry risk assessments and method statements (available on request)
- ✘ They are controlled under law to conform as there are no trade regulation standards to comply with

Health and safety Considerations:

Moving Goods Safely (MGS) is a national project involving both the Health and Safety Executive (HSE) and Local Authorities (LA) working in partnership. The project aims to reduce injuries and ill-health arising from the movement of goods from supplier through haulier to the recipient and end user including any home deliveries. The project will focus upon the delivery and collection of goods and the hazards this generates. It covers the main areas that cause the majority of injuries and ill-health to workers, including:

- ✘ Workplace transport;
- ✘ Slips & trips, and;
- ✘ Musculoskeletal disorders (MSD).

The movement of goods presents us, as health and safety regulators, with the challenge of dealing with a huge variety of issues. The commercial organisations involved within the movement of goods are diverse including haulier, third party logistics providers, pallet networks, retailers etc, with some very large companies, thousands of small businesses and the self-employed. The movement of goods is more than just trucks on the road with a large proportion of accidents happening at the delivery/collection sites that are often not directly under the control of the company making the delivery or collection. Communication and cooperation problems can arise due to the many organizations involved in the movement of the goods, and this can also lead to difficulties in effectively managing health and safety.

(Source H&S Executive UK 2008)

The gates should ALWAYS! be moved with care and attention. The products are very heavy individually as well as a whole. You should not attempt to move this or any other products by unapproved handling methods.



WARNING

Always take safety precautions when lifting and handling heavy objects, in accordance with Manual Handling Operation Regulations 2022.

Always wear correct safety equipment in the vicinity of equipment being off loaded. The gate is to be steadied by means of ropes attached to each end of the gate; preventing it from swinging whilst being manoeuvred. It is important to use the correct nylon slings with a SWL of 2 tonne for each sling.

HANDLING

Due to the size and weight of most D5800 cantilever gates, the use of a mobile crane is required to offload and place into position.

All the D5800 gates come built up and are ready to lift straight onto the Concrete foundation, Once the Lorry has lifted the gate and placed it In the correct position you can proceed to bolt the gate down as shown in the installation on page 07.

A lifting plan must be done before any attempt to lift the gate into position, As sites vary this must be carried out by the installer prior to the gate being Delivered to site.





Diagram below shows a typical D5800 sliding gate highlighting the major parts.

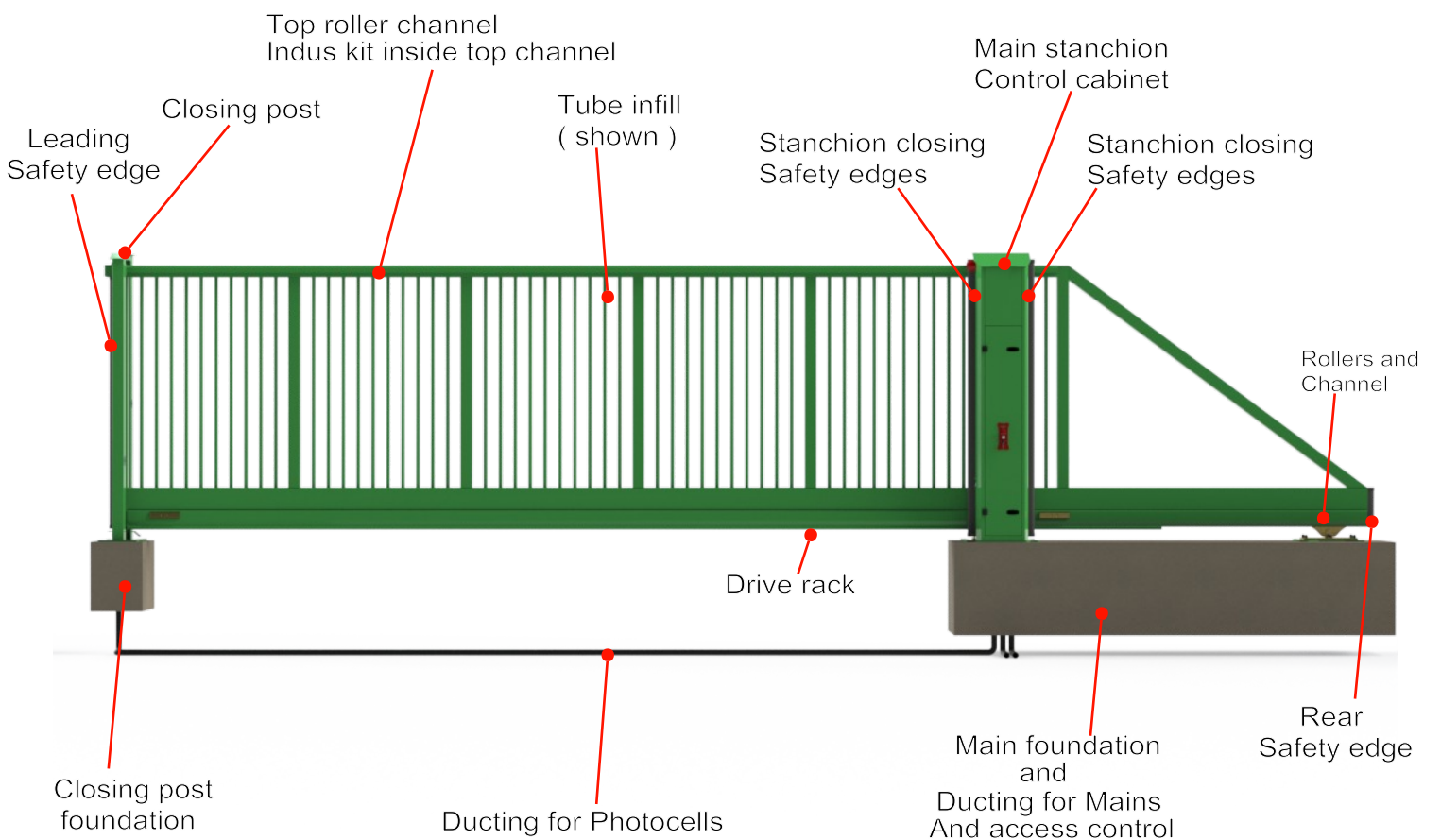

Foundations



All foundations should be installed as per drawing supplied as base size's will vary depending on the size of the gates. (Contact your supplier if you have not been issued one.) All foundations should be installed 10 x days prior to the gates being installed.

If details of the base have not been specified, we recommend a concrete mix to BS EN 206:2013+A2:2021 "Concrete specification, Performance, Production and Conformity" to type C35, which is equally suitable for external and internal environments.

The foundation must be positioned accurately and installed to the correct levels to ensure successful installation.



Careful consideration should be made when deciding the location of the gate to avoid overhead obstructions such as power cables, telephone wires building canopies, trees and other types of likely obstructions and hazards, which will not

Note; The main base contains 3 x ducts which require draw ropes to allow for easy access of the cabling to the gate main cabinet.

Duct 1 is connected across the opening to the closing post allowing easy access for the 24v dc to supply power for the photocells.

Duct 2 can be used to supply the mains power cable to the gate cabinet

Duct 3 can then be used as an access point for all access control cabling. Please note these must be all volt free contacts as our panels give +24v dc to receive it back from the access triggers.



Fixing Kits;

Once The gate is ready to install Please check through your fixing kit to ensure you have all bolts and accessories required. The Basic fixing kit will include;

- 1, 12 x m16 x 180mm Through bolts
- 2, 5 x m8 x 20mm Button head bolts with washers
- 3, 1 x Ramp
- 4, 1 x Catcher
- 5, 1 x Manual release key
- 6, 12 x m16 bolt caps
- 7, 1 x operation and Maintenance manual
- 8, 2 x Key switch keys
- 9, 2 x Cabinet keys



Please note, additional items such as loop detectors, remotes and traffic lights etc can be purchased as extras at the time of quotation or by contacting our spares department and will be issued as extras in your box of fixings.

Physical Installation.

With the gate lifted into position over the foundation, the following steps should be carefully followed to safely install your new gate.

Step 1. Lowering the gate onto the foundations.

Before the gate is lowered into position, the surface of the foundation should be swept clean of any particles or contaminants. The position of the incoming ducts to the stanchion should also be measured with reference to the foundation edges to ensure they are exactly as shown on the supplied drawing.

Carefully lower the gate onto the foundation (figure 1), and ensure the ducts are aligned with the aperture in the stanchion base plate, (figure 2). Keep the HIAB attached to the gate for the time being.



Figure 1

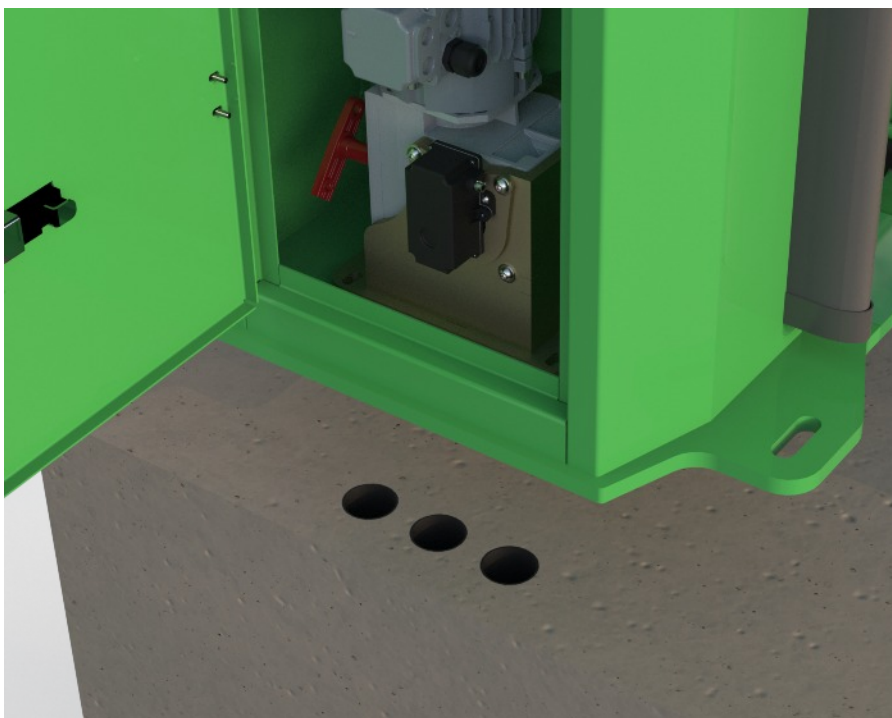

Figure 2

Step 2. Removal of Transportation Stops and Plate.

To allow safe transportation the gate is fitted with two steel stops fitted to the underside of the roller channel (either side of the stanchion) and one steel strap which holds the rear roller to the stanchion base plate.

Ensure the gate is fully supported on the foundation and then remove the two stops using the using an 17mm wrench. See figure 3.

Remove the steel strap between the stanchion and rear roller in a similar fashion. See figures 4a and 4b.

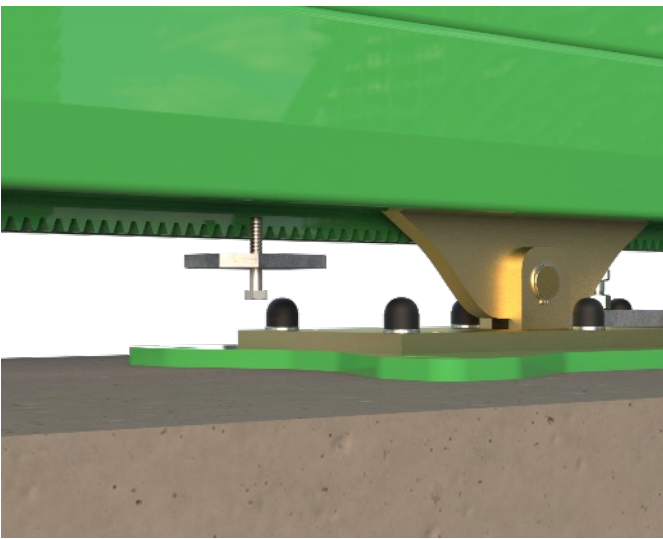

Figure 3

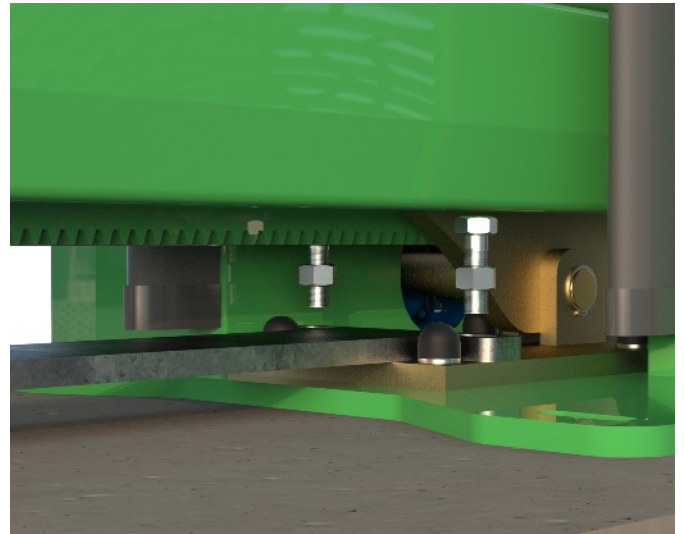

Figure 4a



Figure 4b

Please ensure the transport plate and mechanical stops are returned with your delivery driver as failure to do so could result in extra costs on future products, many thanks

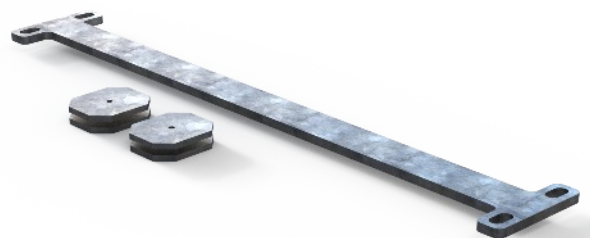

Figure 4c

Step 3 Positioning the Rear Roller and Aligning the Gate.

Using the attached HIAB crane, relieve the weight of the gate on the rear roller assembly until it is possible to slide the roller along the gate roller channel.

Using a tape measure as reference, carefully move the rear roller carriage along the foundation until it is at the correct distance from the rear of the stanchion base plate. As shown on the provided drawing. Note. This measurement needs to be accurate to ensure proper operation of the gate. See figure 5.

Using a string line or laser, check the alignment of the gate in relation to the foundation and closing post location and adjust as required. Figure 6.

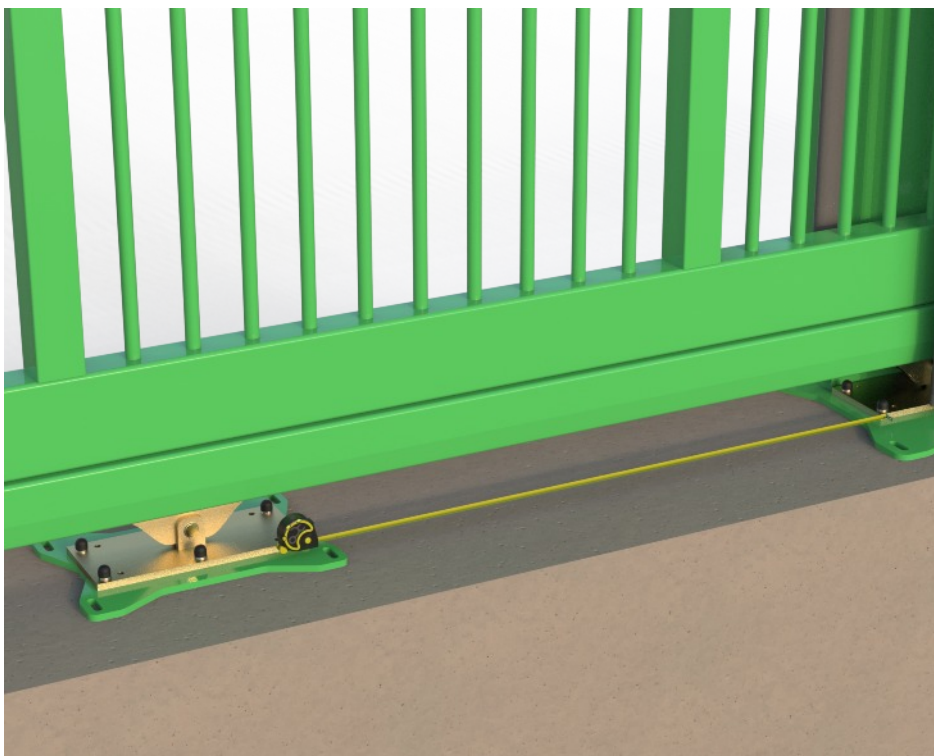

Figure 5



Figure 6

Step 3 Positioning the Rear Roller and Aligning the Gate - continued.

To ensure that the gate is in the correct location with reference to the closing post, measure the distance from the rear of the cantilever section to the rear of the Roller Plate (figure 7), and ensure that this dimension is greater than the measurement between the front of the gate leaf and the centre of the closing post foundation (figure 8). This is to make sure that the distance the gate leaf has to travel to be fully closed is less than the amount of travel available.

Finally a check must be made to ensure that the rear roller and stanchion are perfectly aligned along the centre line of gate travel (figure 9). Any misalignment of the stanchion or rear roller should be eliminated to allow the gate to travel freely (misalignment will cause noise in operation and undue wear to the rollers gate channel and drive system).

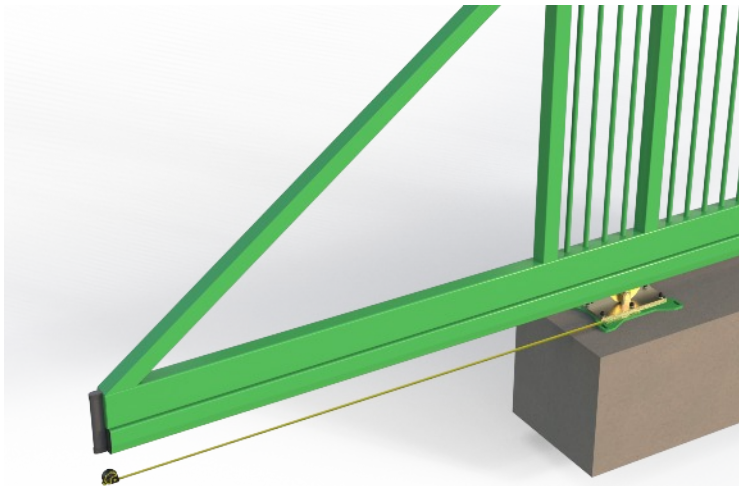

Figure 7

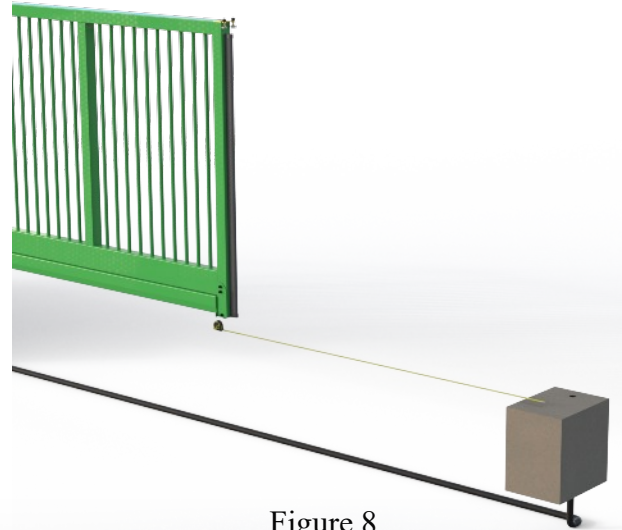

Figure 8

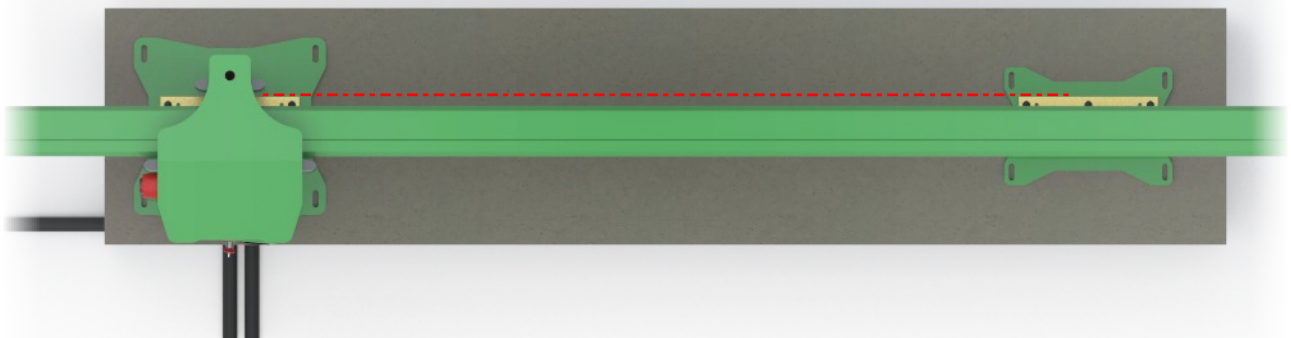

Figure 9

Step 4. Bolting Down to the Foundation.

When happy with the gate placement and alignment, drill the fixing holes for the rear roller into the foundation using a suitable M16 drill. Brush away any concrete dust and then insert all four fixings, drive them fully home with a hammer and then tighten fully using a suitable wrench. Figures 10a & 10b.

At this stage, re-check the alignment of the whole assembly, and ensure that the stanchion and rear roller are still perfectly aligned with the centre line of the gate. The fixing holes for the stanchion can now be drilled, and hold down bolts installed and tightened as per the above procedure. Figures 11a & 11b.

Finally, re-check the position and alignment of the closing post, then drill and bolt down as above. (Figure 12).



Figure 10a

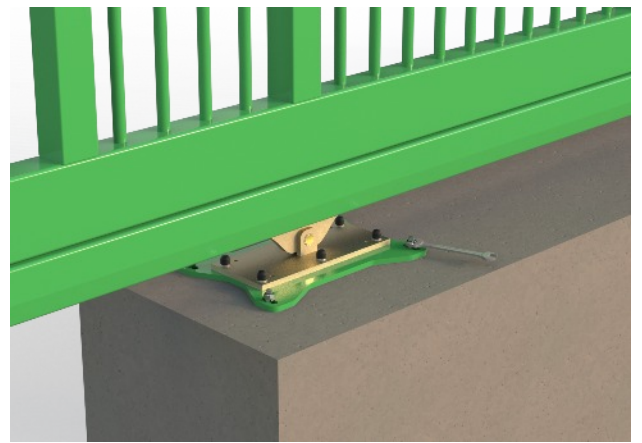

Figure 10b



Figure 11a

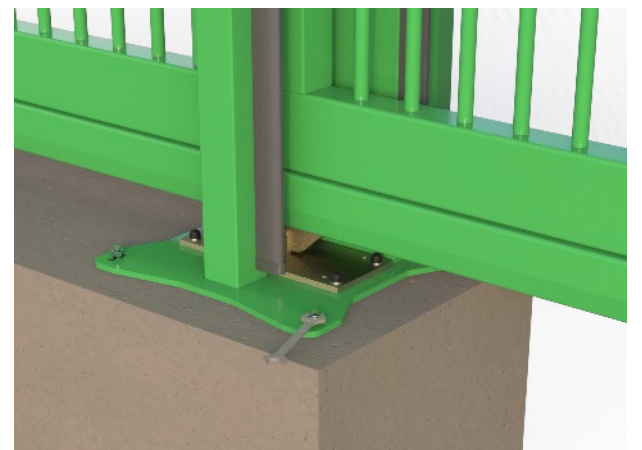

Figure 11b



Figure 12

Step 5. Connecting The Photocells.

Note; The photocells are pre wired into two separate channels which allows us to wire both receivers into the gate station and series the photocell contacts into the board before dispatch from our workshop. This in tern makes installation easier as you are only required to send 24v across to the closing post to power the transmitters.

Note; The internal photocells are switched to channel 2 by the pink from the receiver and the black cable from the transmitter wired into the positive supply.

To Connect the photocells Please remove the cover plate from the top centre of the closing post by undoing the 2 x m6 bolts this will require a 4mm Alan key. As shown in figure 13

Once removed you will find 2 x wagos ready to connect your 24v too, This can be achieved by connecting the positive 24v into the wago containing the 2 x brown and 1 x black wires, And the negative 24v into the wago containing the blue wires.

Back at the station this will just be a case of connecting in to the auxiliary 24v supply from our terminal blocks, 29 being positive 24v and 30 being negative 24v. Please see following page.



Figure 13

Step 5 continued;

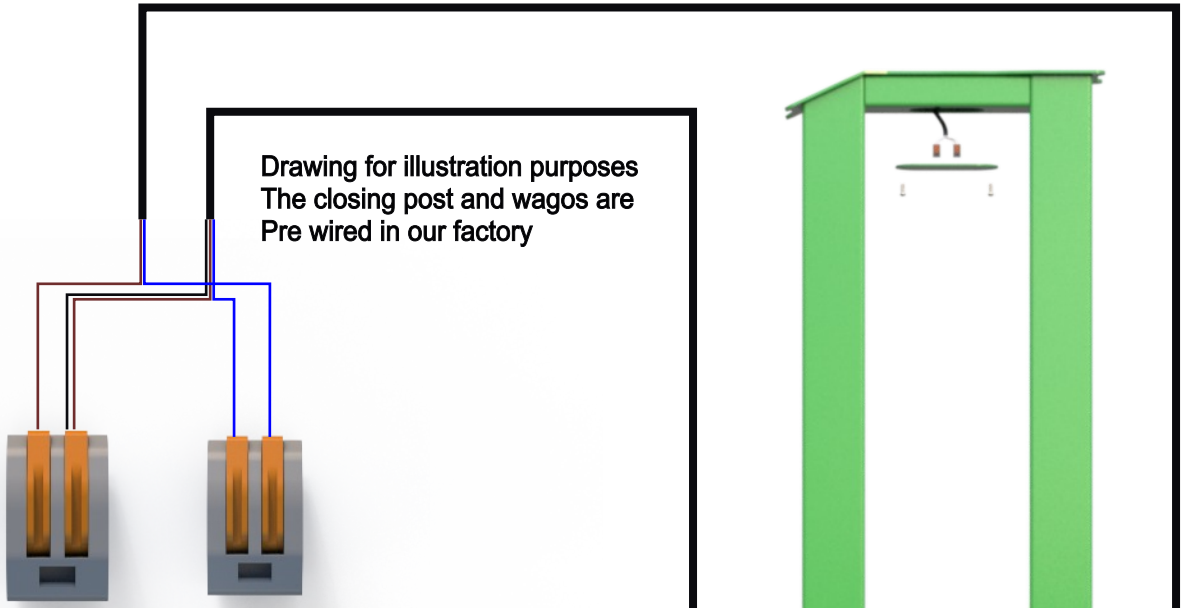

Please note the internal photocell is pre wired to Channel two via the black being added with the Positive connection

The green terminal blocks can be found
In the gate main station

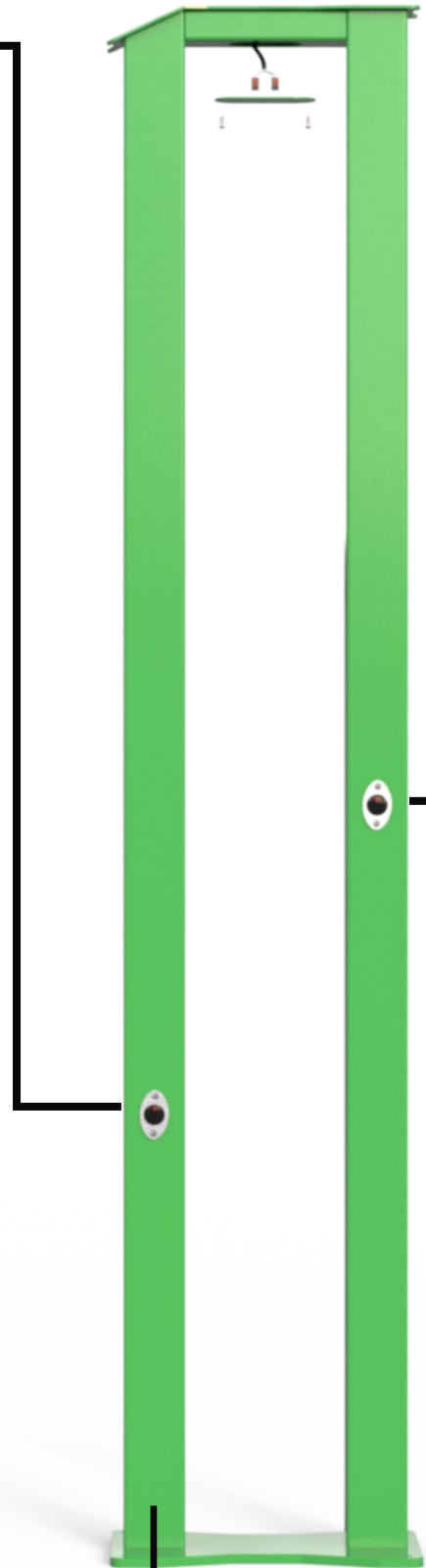
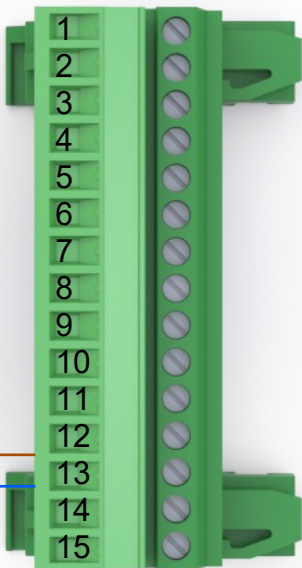

Step 6 Closing post

Figure 17

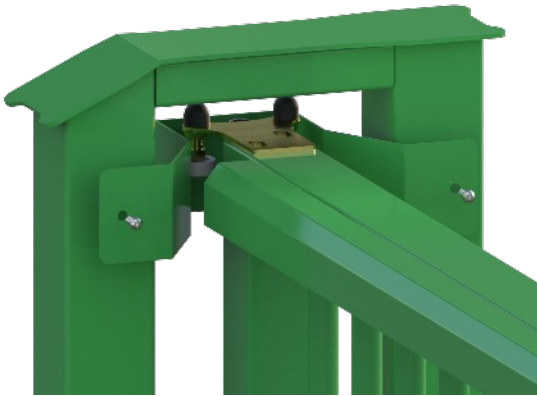

To install the catcher fully close the gate and offer the catcher up to the closing post so that the guide wheels are fully covered by the catcher guide. See figure 17

Drill the closing post once you have marked the catcher holes with a 7mm hss drill bit this can then be tapped with an 8mm tap and secured using the provided m8 bolts and washers using a 5mm Alan key. See figure 18

Figure 18



Figure 19

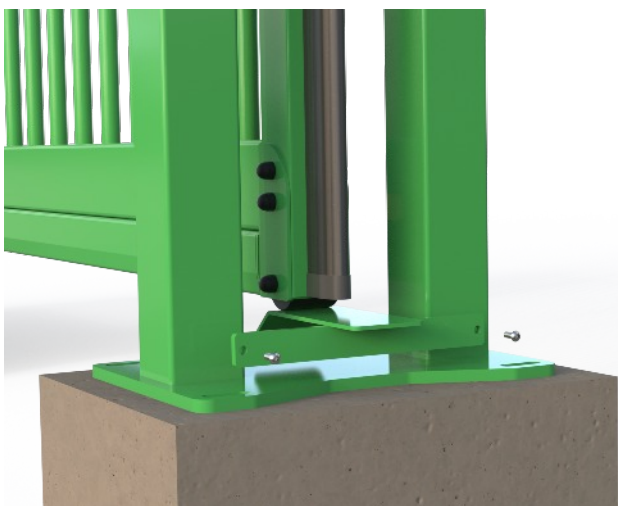

The ramp is installed by closing the gate and offering the ramp up to the front guide wheel. Then making a mark where the ramp sits. As this is a resting point for the cantilever gate and will support some of the weight it is suggested that the gate is rolled back prior to drilling and the ramp lifted approximately 3mm from the marked position. This again can be attached with a 7mm hss drill bit and 8mm tap. And using the supplied m8 bolts and washers. See figure 19.

Please now lock the motor back in to automated running
This can be done with your manual release key.
This should be hand tightened only and given an extra slight turn
To ensure the motor and clutch are engaged.



Now that your gate is fully mechanically installed it
Is now time to connect your mains supply. This is 230 v 16 amp
single phase supply.

Please Note this supply must be installed and connected
By a fully qualified electrician and must confirm to BS 7671 and be fully tested
To ensure minimal earth leakage. As our gates are inverter driven and the inverter
Itself contains earth leakage filters the supply must be connected
And tested properly and installed from an mcb as apposed to an rcd.
Failure to do so could result in improper function of your gate and therefore alter the gates
Ability to comply with all current regulations.

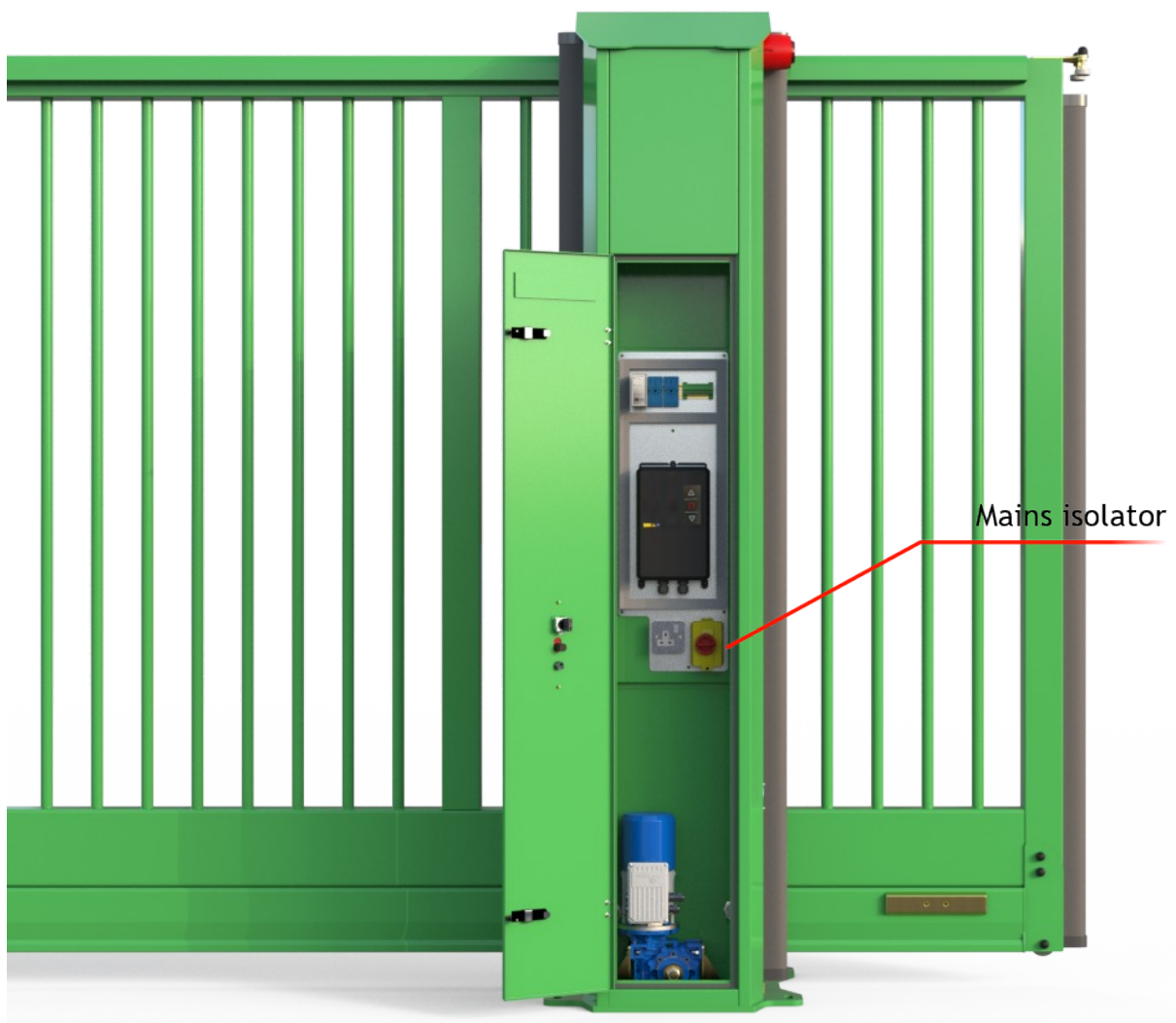

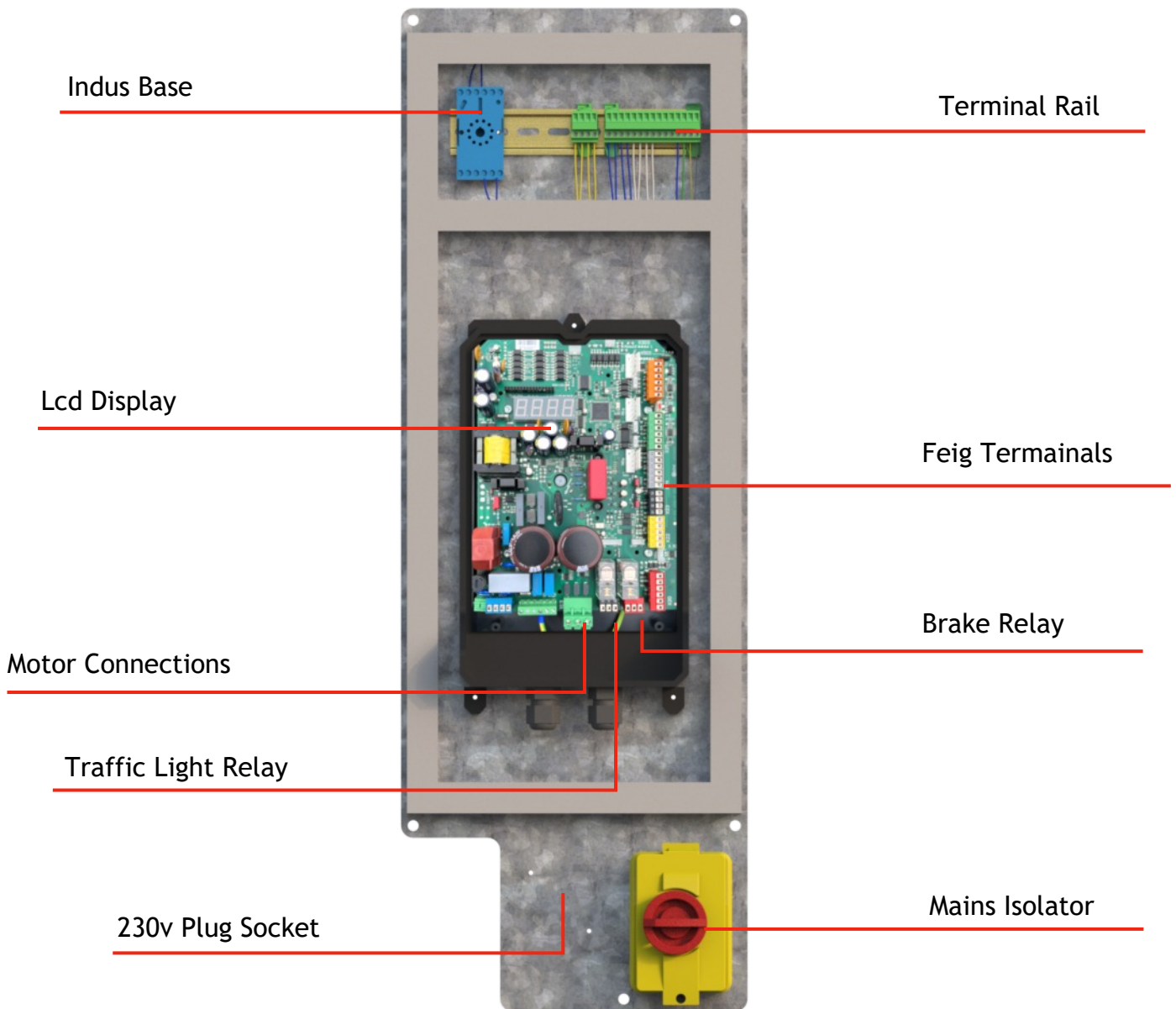

Above shows the layout of a D5800 gate panel which will help identify any main components.



At the front of the control cabinet you will find our fully labelled door control unit this incorporates the emergency stop button which when pressed will over ride all gate functions and keep the gate stationary where activated. This can be released with a slight twist to allow operation of the gate.

In addition you can find our open / close key switch which also works with our emergency dead man function.

Please note in the event of a safety device failure the gate incorporates a dedicated deadman function.

The gate can be operated via the hold to run key switch located on the cabinet door panel simply hold in the direction you would like the gate to operate

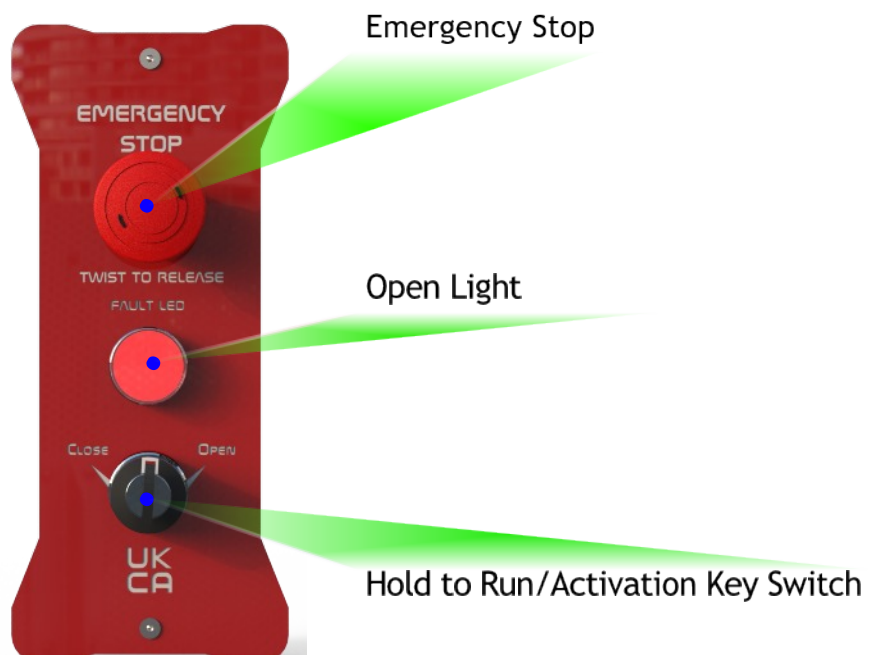

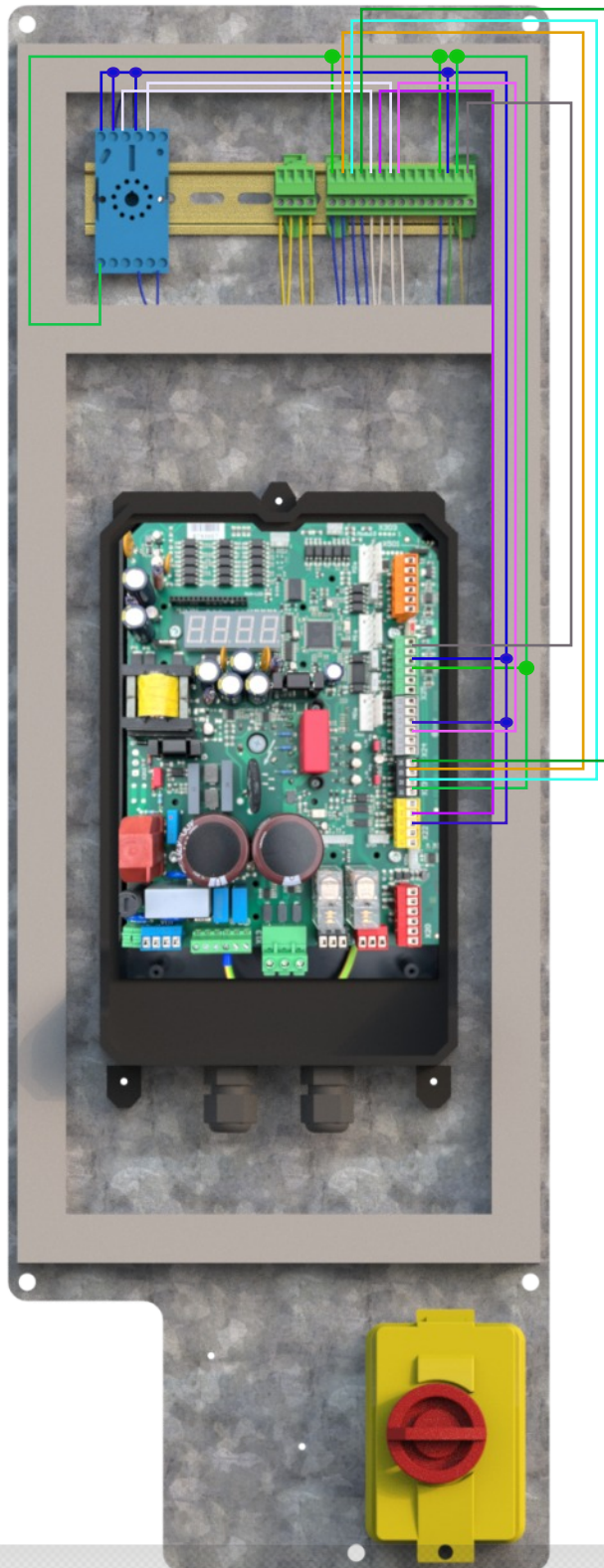

- +24v dc
- -24v dc
- - common for edges
- Close edge
- Open edge
- Photocell
- Stop
- Open
- Close

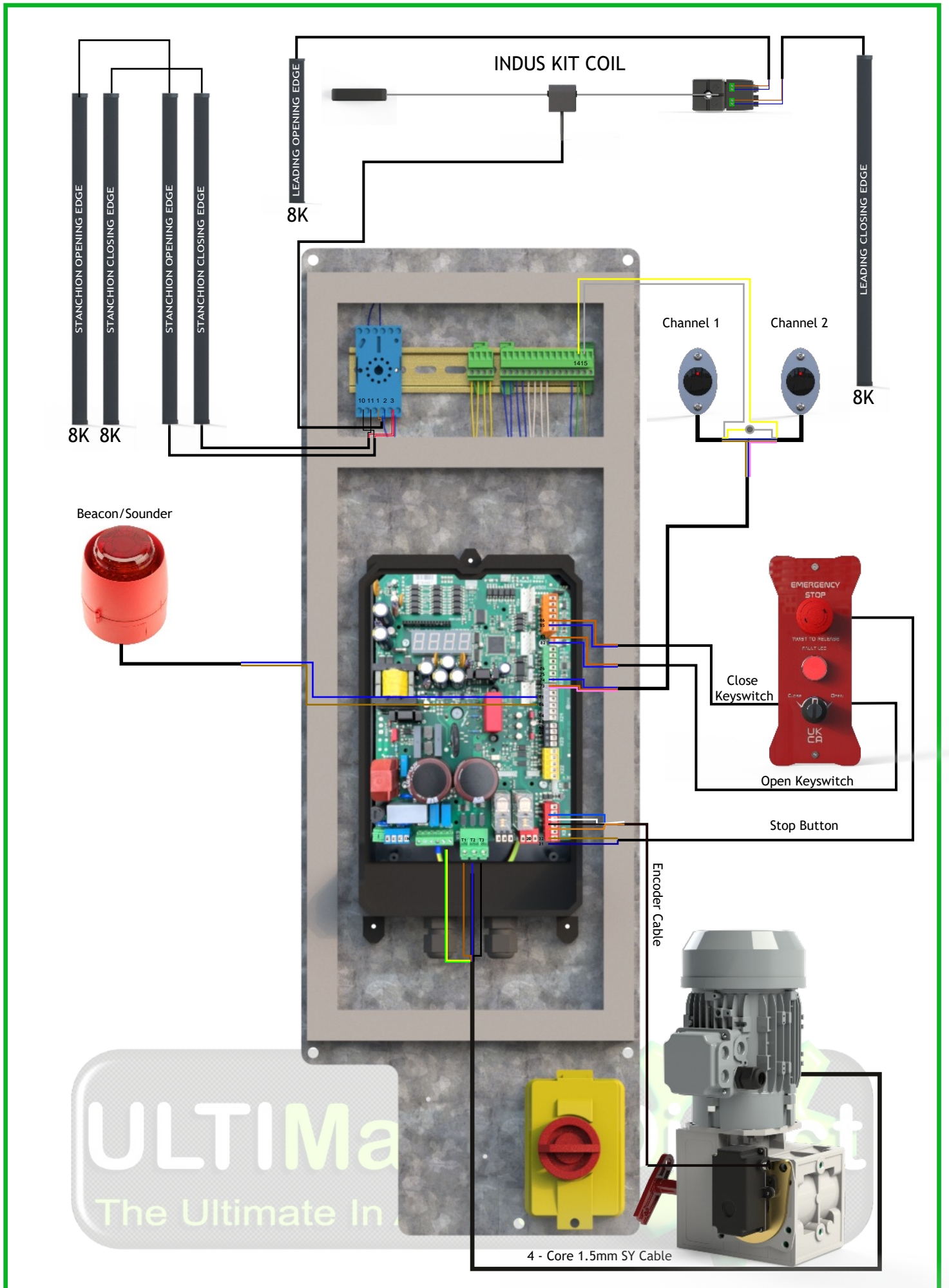

ULTIMa
The Ultimate In

- 86 Common +24v dc
- 85 Open Dead Man
- 84
- 83 Common +24v dc
- 82 Close Dead Man
- 81
- 76 Common
- 75 Photocell
- 74 Ground -24v dc
- 73 Common +24v dc
- 72 Pedestrian Open (Common from 73 if used)
- 71 Ground -24v dc (Common for opening edge)
- 66 Beacon Sounder (common from 71)
- 65 Open Edge 8k2 Input (common from 71)
- 64
- 63 Ground -24v dc
- 62 Common +24v dc
- 61
- 54 Close Input
- 53 Stop Input (link from 51 if not used)
- 52 Open input
- 51 Common +24v
- 45
- 44 Ground -24v (Common for Close Edge)
- 43 Close Edge Input (Common from 44)
- 42 Common +24v dc
- 41 Stop Input (Link from 42 if not used)
- 36 Ground
- 35 Channel B
- 34 Channel A
- 33 +12v
- 32 Common +24v dc
- 31 Stop input (Link from 32 if not used)
- 22
- 21 +24v dc Link from power supply if mag requested
- 20 Maglock Positive feed
- 12 Green Traffic Light +24v dc
- 11 +24v dc Link
- 10 Red Traffic Light +24v dc

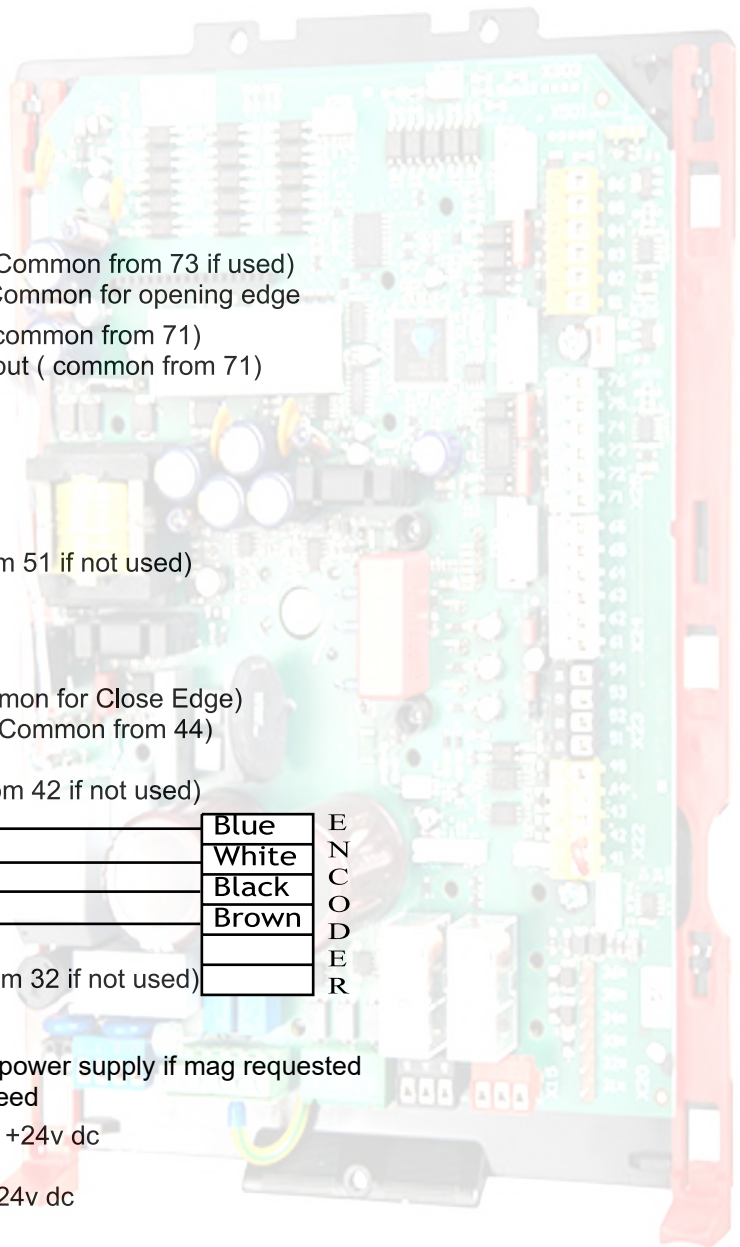

| | | | |
|----|---------------------------------------|-------|---|
| 36 | Ground | Blue | E |
| 35 | Channel B | White | N |
| 34 | Channel A | Black | C |
| 33 | +12v | Brown | O |
| 32 | Common +24v dc | | D |
| 31 | Stop input (Link from 32 if not used) | | E |
| | | | R |

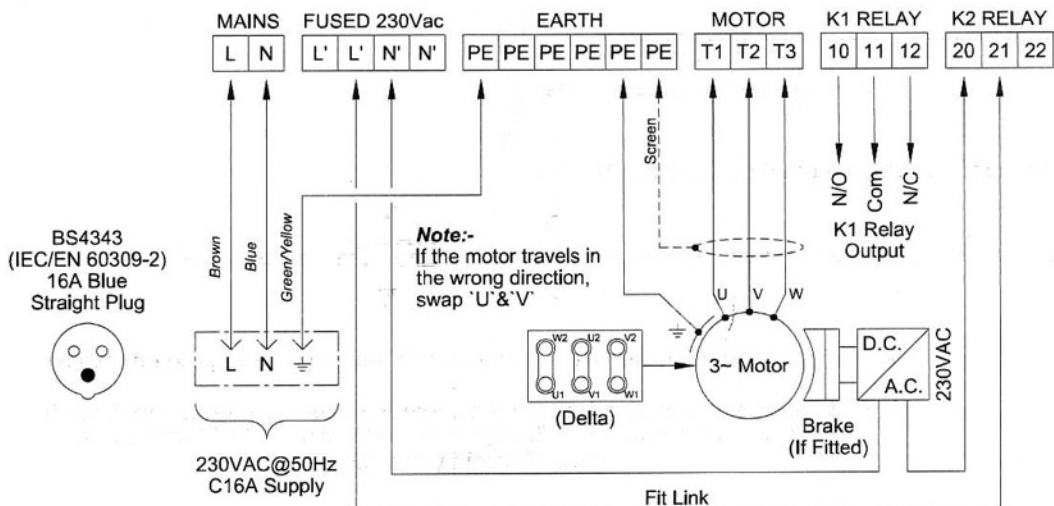

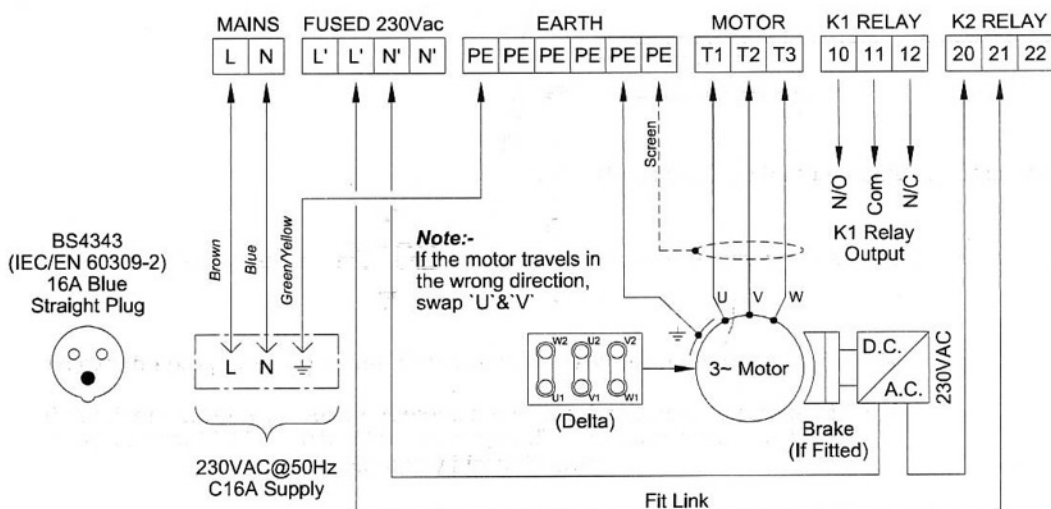
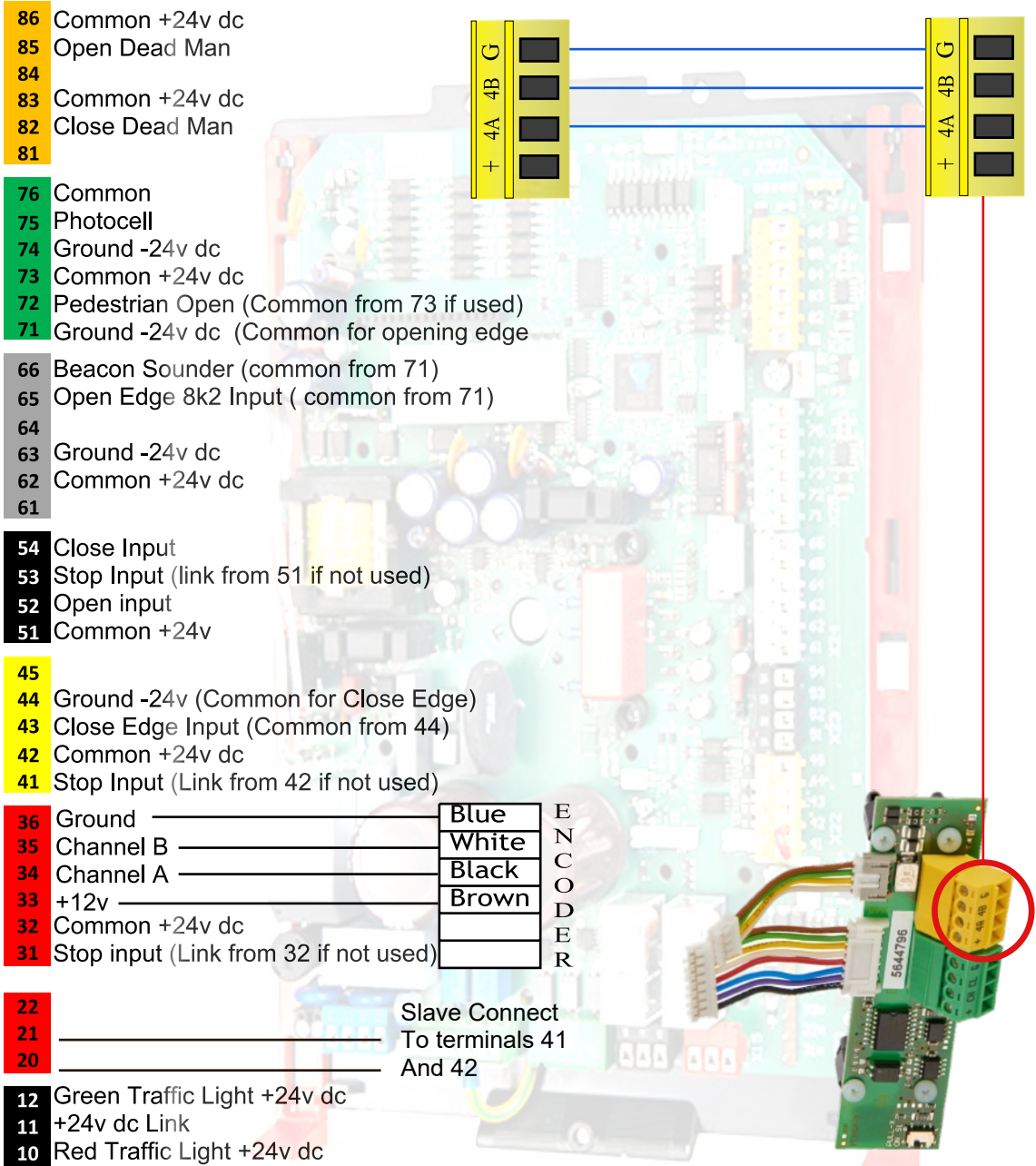

1. Loop Channel 1
2. Loop Channel 1
3. Loop Channel 2
4. Loop Channel 2
5. Common +24v dc
6. Stop N/C
7. Open N/O
8. Close N/O
9. Open Edge In
10. Open Edge Out
11. Close Edge In
12. Close Edge Out
13. Free
14. Free
15. Free
16. +24v dc (For slave photocells)
17. -24v dc (For slave photocells)
18. Photocell common (yellow)
19. Photocell contact (Grey)

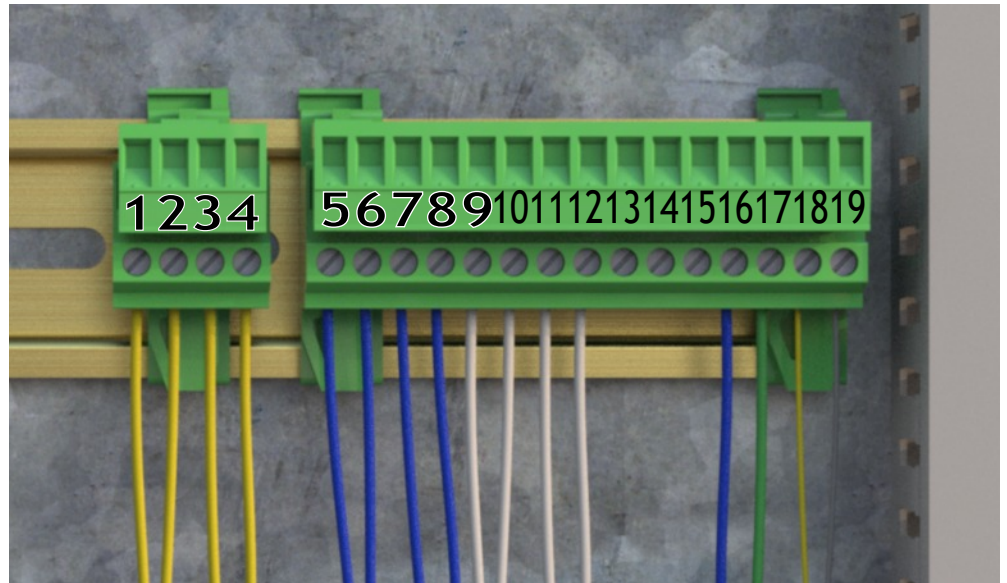

Safety and Auto loop bases

We now use the feig plug in loop cards for convenience of the engineer. If ordered with the product this will arrive with tails pre wired into the green terminal strip.

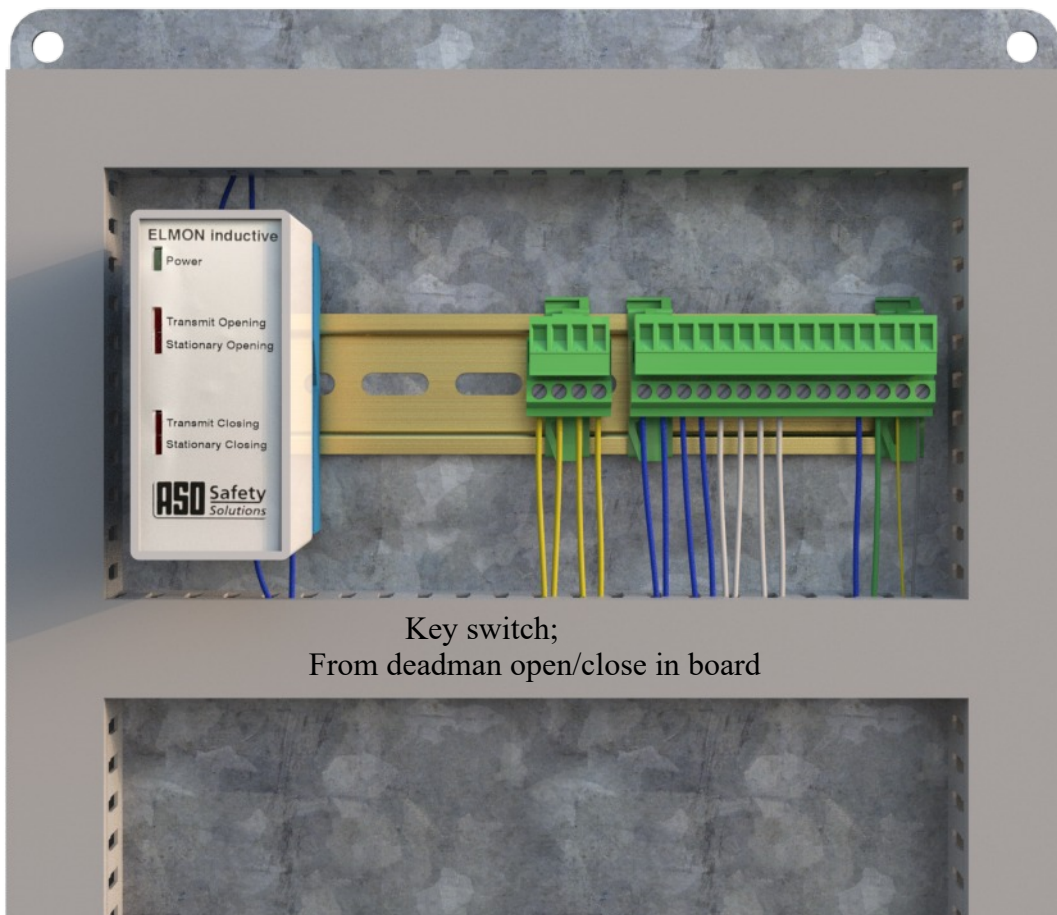

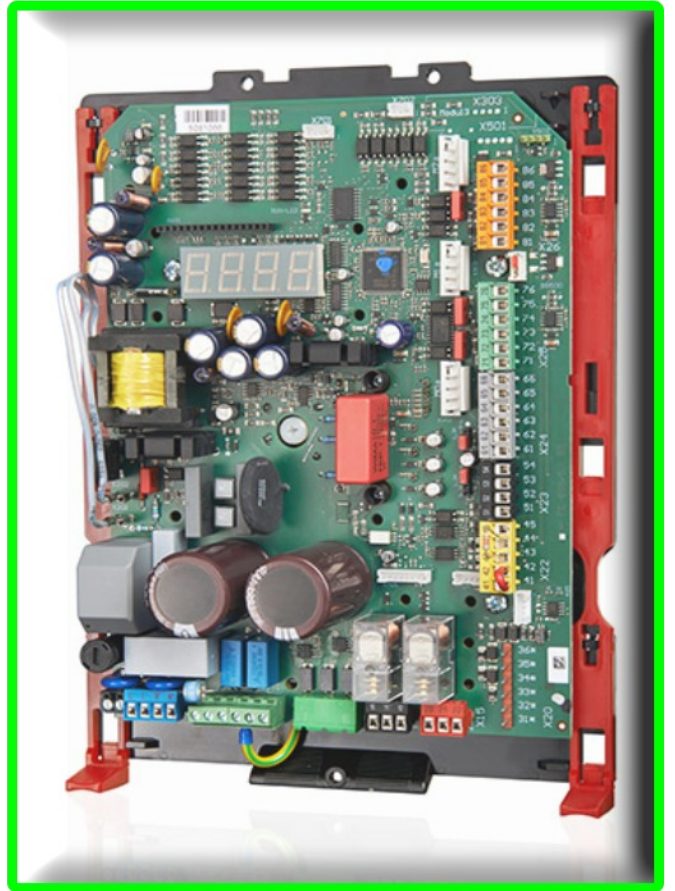

At the front of the control cabinet you will find our fully labelled door control unit this incorporates the emergency stop button which when pressed will over ride all gate functions and keep the gate stationary where activated. This can be released with a slight twist to allow operation of the gate.

In addition you can find our open / close key switch which also works with our emergency dead man function.

Please note in the event of a safety device failure the gate incorporates a dedicated deadman function.

The gate can be operated via the hold to run key switch located on the cabinet door panel simply hold in the direction you would like the gate to operate



Emergency Stop

Open Light

Hold to Run/Activation Key Switch

Guide to inputs Commonly Used,

| | | |
|-------|------|--|
| P.100 | 50HZ | Motor Frequency |
| P.101 | 1.7A | Motor Current |
| P.102 | 74% | Motor Cos |
| P.103 | 230V | Motor Voltage |
| P.205 | 0800 | Encoder Setting |
| P.202 | 10 | Resolution/ Increments of Travel Allowed |
| P.216 | 1 | Slow positions Pre-set |
| P.222 | 300 | Close Slow Position |
| P.223 | 300 | Open Slow Position |
| P.310 | 30HZ | Open Speed |
| P.312 | 100 | Acceleration Open HZ per second |
| P.320 | 10HZ | Open Slow Speed |
| P.322 | 15 | Open Ramp |
| P.332 | 500 | Deceleration After Opening Edge Activation |
| P.350 | 30HZ | Close Speed |
| P.352 | 100 | Acceleration Close HZ per second |
| P.360 | 10HZ | Close Slow Speed |
| P.362 | 15 | Close Ramp |
| P.372 | 500 | Deceleration After Close Edge Activation |
| P.420 | 3 | Pause Time on Safe Edge Reversal M/S |
| P.70F | 0801 | Output 15 Set to Beacon Sounder |

Closing Edge,

| | | |
|-------|-----|--|
| P.460 | 1 | 8K2 Edge |
| P.467 | 16 | Reverse Increments During Closing according to P.4xB |
| P.4DB | 400 | Reversal Increments |

Opening Edge,

| | | |
|-------|-----|--|
| P.5A0 | 14 | Input 10 Safety A |
| P.5A1 | 10 | Reverse Increments During Opening according to P.4xB |
| P.5A2 | 2 | Input 10 8K2 |
| P.4AB | 400 | Reversal Increments |

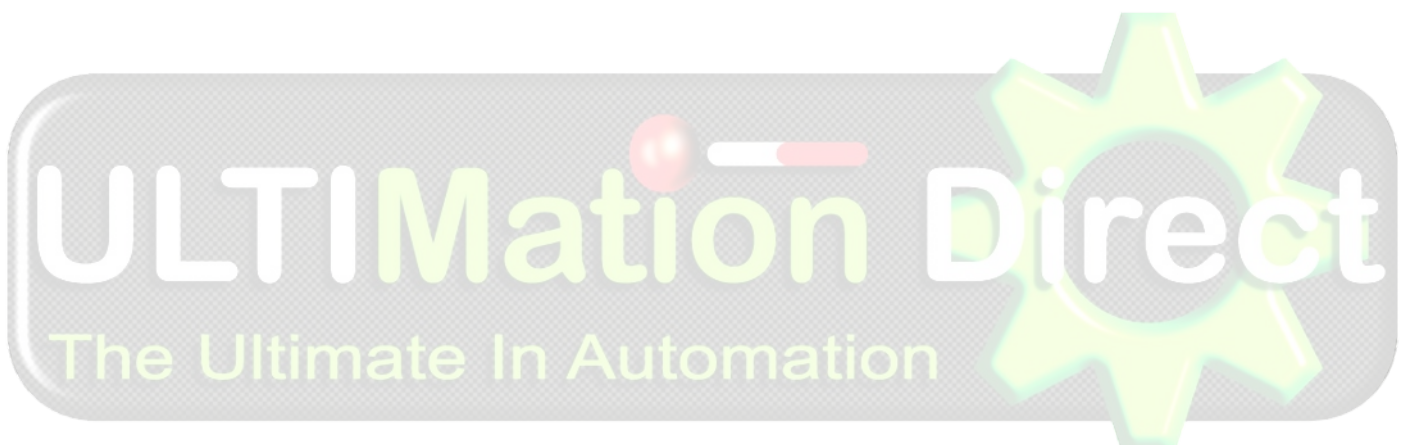

When you have the gate powered and ready to run please follow the next few steps to initially set up your encoder run positions. This will only need setting once.

Figure 1

Step 1;

Once powered up provided there are no faults the board will display the message Cali, this is asking you to calibrate the encoder. Figure 1

**Step 2;**

When ready press the stop button briefly. The board will now display The EI-EC asking you to sync to close position. Note the dots between the letters will be flashing.

Figure 3

Step 3;

Simply hold the down arrow to close the gate to its desired position, don't worry if you let go early simply press the down to jog the gate to position. Once at your desired close position press and hold the stop until the dots stop flashing this will record the close position and then revert to the open sync, Figure 4

**Step 4;**

Please now using the up arrow move the gate to its desired open position. Again once happy press and hold the stop button until the dots stop flashing to store the open position.

**Step 5;**

The gate is now set and ready to operate, before testing safeties I would advise at this point to give the gate an open and close operation to ensure the positions are correct and you can see the slow downs and ramps operating correctly.



Step 6,

If you are now happy with the gates positions please test all safeties as normal, i. e all edges and photocells. The gate also now incorporates a force detection this will require a firm push to the leaf to enable its operation whilst the leaf is travelling. The leaf once force detected will move to its opposite position and stop. If The gate positions need resetting please follow the following few steps to re calibrate the encoders.

Step 7,

Should we need to reset the positions on the gate please follow these steps.

You will need to access the parameters menu. This can be done by pressing and holding the stop and up arrows together. See figure 6

Figure 6

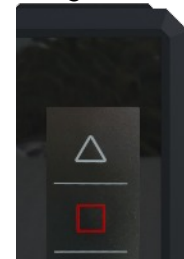
**Step 8,**

Navigate through the menu to parameter 999 (figure 7) using the up arrows. (Note holding the down arrow and pressing the up will move through parameters in blocks of ten for ease)

Figure 7

**Step 9,**

Once at P999 press and the stop button this will enter the parameter allowing you to change the value. Please set this to number 3 using the up arrows and confirm by holding the stop again for 2 seconds. Figures 8 and 9) to exit the parameter just press the stop key.

Figure 8

**Step 10,**

Now navigate through the menu to parameter 210 and set this to 5, this will reset the encoder allowing you to re calibrate the gate. Please follow previous steps until you are happy with the positions and safeties.

Note This setup is the same for single leaf and master and slave. The buttons will only work the leaf to which they are installed. To test both leaves on a bi parting gate, (double leaf) please use the open and close inputs on the board.

Position set up;

Should your gate run out of travel during the set up process then you will need to alter the P202 Parameter this is pre set to 8, any alterations made will double the increments of travel so 9 will be double 8, 10 will be double 9 and so on. Common practice is to have P202 set to the minimum amount achievable. The board has a maximum of around 3000 increments of travel. To alter follow the instructions previously shown to access the full menu, You will Then be able to access the 202 parameter. If in doubt the gates travel can be checked with parameter 230. This will give you the full travel increments of the gate ideally we are looking for this to be around 2000 for your pre set slow downs to be at a good distance.

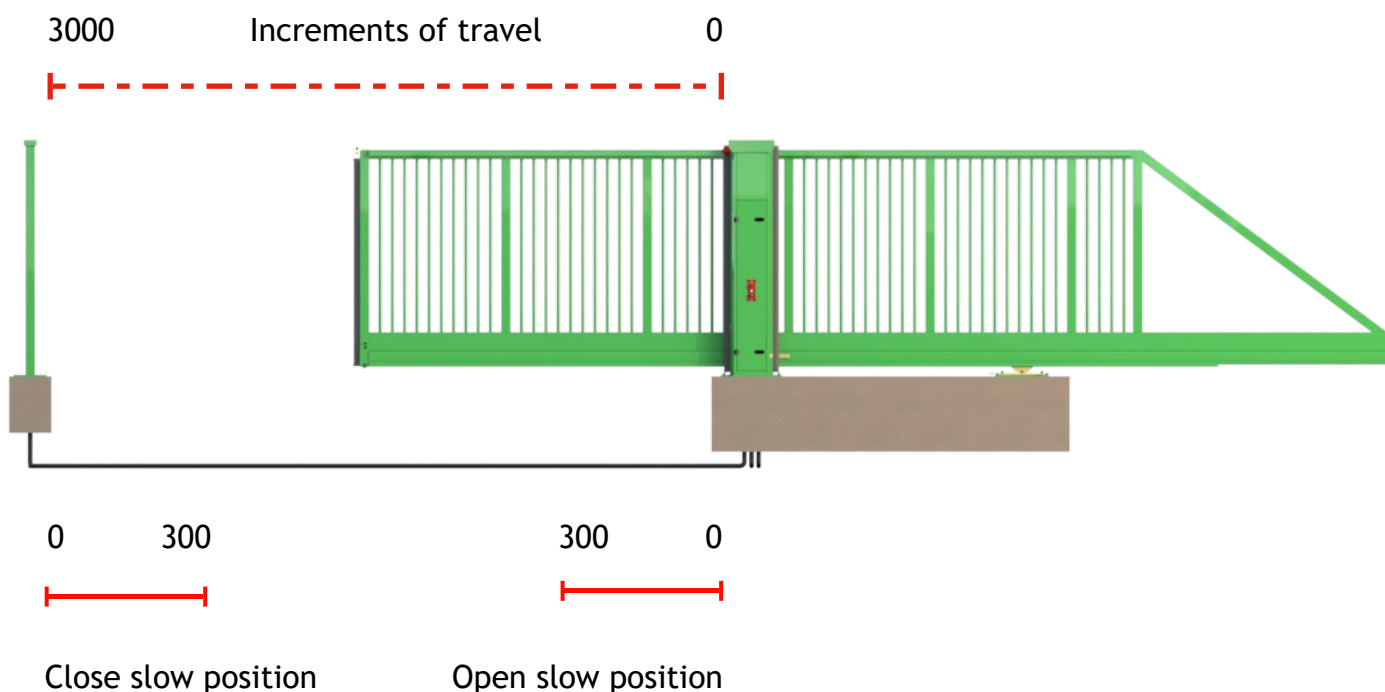

Slow down set up;

To adjust the slow down positions Please access P222 for close slow down and P232 for open Slow down. These parameters are pre set too 300 increments from there respective limits, Therefore to reduce the slow distance 300 would be reduced for example to 200, to increase Please add to the slow down so 300 would become 400 as an example.

Auto close options explained;

The auto close functions can be accessed through the parameters menu, For the no passage timer P010 can be easily accessed without having to access the full menu, As standard this is pre set to 30 seconds. This can be altered to your desired time in seconds, should you wish to turn this Parameter off simply set the timer to 0 which will turn the timer off.

Loop / Photocell close, To adjust the loop photocell close there are a few settings which govern this parameter. The full menu will need to be accessed, once this has been done You will need to navigate to P4B7 this parameter will be set to 0 which is off, should you Wish to turn this on set 4B7 to 2 which will enable the parameter.

Now the photo close is active we have a couple more options to add a delay to the photo close P025 can be adjusted to allow this however a delay here will also delay all close commands Therefore should you wish to give the gate a close command via access controls and this input not be delayed P535 will need to be set to 0. This will disable the timer on the close input command



Within the panels display you are able to set the speeds of the drive to enable you to fine tune the gate drive as per site requirements.

Select parameter code P999, Press 3 to unlock the menu to gain access to the below drive settings.

| <i>Motor Code</i> | <i>Operation</i> | <i>Frequency</i> |
|-------------------|--------------------|------------------|
| P310 | Opening Speed | Hz |
| P320 | Opening Slow Speed | Hz |
| P322 | Opening Ramp | Hz per second |
| P350 | Close Speed | Hz |
| P360 | Close Slow Speed | Hz |
| P362 | Closing Ramp | Hz per second |
| P312 | Open Acceleration | Hz per second |
| P352 | Close Acceleration | Hz per second |

Should you encounter any errors or make a mistake whilst programming you can enter the full programming menu, Go to parameter 990 and set to number 2 which will reset the panel to our initial programme as factory set.

Note: when a safety edge is activated the drive will automatically back off in it's quickest possible time. You can also use the slow speed setting to alter your force test results if needed.



To set the timers on the feig board follow the instructions to access the full parameters 999 set to 3, The timers can then be adjusted as follows to suit site requirements. Please note with timers and parameters setting them to the 0 position will turn the timer off.

| Parameter | Description | Timers |
|-----------|---------------------|--------|
| P010 | No Passage Timer | 30 |
| P020 | Open Delay Timer | 0 |
| P025 | Close Delay Timer | 0 |
| P712 | Traffic Light Delay | 0 |

Customisable parameters, below is a list of parameters and functions that are offered with the control board please note the feig controller does not have a built in time clock. These can be supplied on request and programmed to suit site requirements.

| Parameter | Description | Values |
|-----------|------------------------|-------------------------------------|
| P000 | Cycle Counter | Full Gate Cycle |
| P005 | Maintenance Counter | Counter Set Between Service Periods |
| P920 | Error Log | Last 8 Errors |
| P925 | Software Version | Current Software Version |
| P985 | Language | 0 = English |
| P232 | Open Slow Down | In Increments Of Travel |
| P222 | Close Slow Down | In Increments Of Travel |
| P582 | Normally Closed Limits | 0 = On 1 = Off |

Output Configuration,

The 2 x relays on the feig controller can be adjusted to control a number of options. These can be found in the list below.

For ease Relay 1 = P701. Relay 2 = P702

The function of the output relay can be specified using this profile. All parameters needed for the function of the output are changed in one step.

- 0000: Output deactivated
- 0001: Continuously turned on
- 0101: Door is Open

The message depends on the logical status of the door

- 0103: Door is Open

The message depends on the position of the door

- 0201: Door is Closed

The message depends on the logical status of the door

- 0203: Door is Closed

The message depends on the position of the door

- 0401: There is no error
- 0501: Courtyard light function, switched ON during opening and closing with 10 s switch off delay after closing.

- 0601: Passing on detector channel 1
- 0602: Passing on detector channel 2
- 0605: Synchronous control OPEN, signal duration 0.5 seconds.
The output is active during opening, in End position OPEN and during locking in end open position.

- 0606: Synchronous control CLOSE, signal duration 0.5 seconds.
The output is active during Closing, in End position Close and during locking in end position close.

- 0607: Synchronous control STOP, signal duration 0.5 seconds.
The output is active when the door is not moving, no end position is approached and no locking in any end position is active.

- 0612: Passing on leaving detector 1
- 0613: Passing on leaving detector 2
- 0630: Forwarding Brake
- 0634: Forwarding, of a low Battery from the WiCab mobile Unit
- 0659: F.363: forwarding disturbance of the internal safety edge.
- 0660: Forwarding: maximum number of trips of the safety edges has been exceeded.

- 0665: Forwarding detector channel 3
- 0666: Forwarding detector channel 4
- 0701: Flashing during opening and closing
- 0703: Switched on during Opening and Closing
- 0801: Active during opening and closing and during active pre-warning / clearance time.

- 1001: Locking second door
- 1002: Locking second door, 1 s switch off delay

- 1101: Magnet voltage in end position CLOSE



The N.C. contact of the relay has to be used

- 1102: Magnet voltage during Closing and in end position CLOSE

- 1201: Green traffic light on inside of door
- 1210: Green traffic light on outside of door
- 1220: Red traffic light on inside of door 1
- 1221: Flashing red traffic light on inside of door 1
- 1222: Red traffic light on inside of door 2
- 1223: Flashing red traffic light on inside of door 2
- 1224: Red traffic light on inside of door
- 1232: Red traffic light on inside
- 1233: Red traffic light on inside, inverted
- 1250: Red traffic light on outside of door 1, flashing during clearance time
- 1251: Flashing red traffic light on outside of door 1
- 1252: Red traffic light on outside of door 2
- 1253: Flashing red traffic light on outside of door 2
- 1255: Red traffic light on outside of door
- 1263: Red traffic light on outside
- 1264: Red traffic light on outside, inverted
- 1295: Green traffic light, flashing during pre-warning / clearance time, ON in end position OPEN
- 1298: Direction dependent red traffic light. On for opening and closing movement. Off when CLOSED and when OPEN. Flashes during evacuation time
- 1601: Airlock OPEN
- 1701: Testing in end position close
- 1801: Counting +



The function is only possible with detectors 1 and 2. At first you have to activate the + loop and then the - loop.

- 1901: Counting -



The function is only possible with detectors 1 and 2. At first you have to activate the - loop and then the + loop.

- 2001: Warning light 1, always ON if door is not closed.
- 2101: Warning light 2, switched ON during closing
- 2201: Active green traffic light, ON in endposition OPEN until a close command is given or detector 2 gets active.
- 2301: Active green traffic light, ON in endposition OPEN until a close command is given or detector 1 gets active.
- 2501: Testing in endposition OPEN
- 2601: Emergency opening test
- 3201: Output function brake
- 3202: Output function brake (N.C., output turned)



The exact settings which this profile involves can be found in Appendix Output Profile.

Installing a Loop Detector

The loop board can be added to your Feig controller as per the diagram these simply push in for ease and allow easy control for single or dual channel.

L.E.D Indications

- Green fast flash - Detector Tuning
- Green Solid Light - Detector is ready
- Green and Red on - Loop detecting
- Red Solid Light - Loop Fault

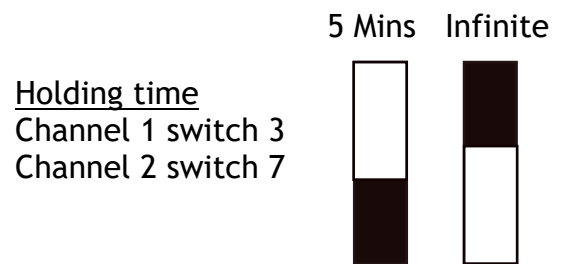
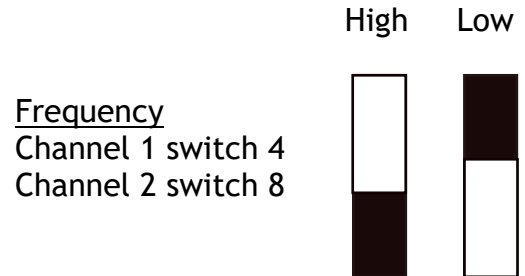
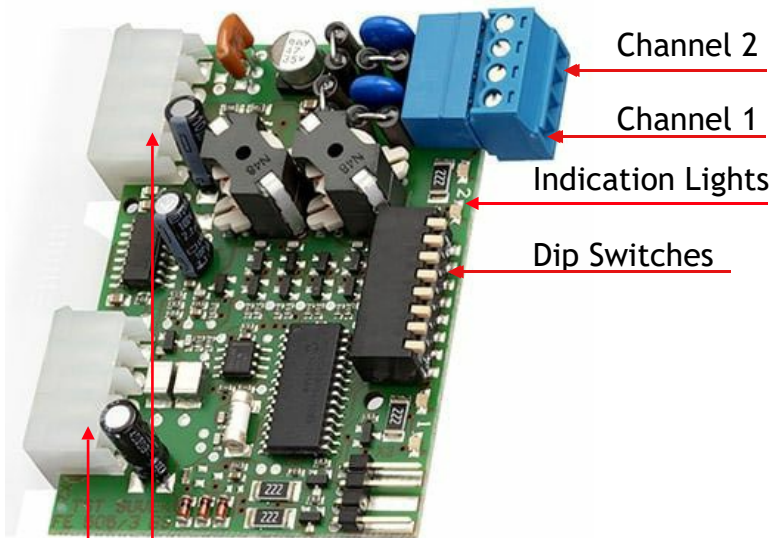

Dip switches 1 and 2 for sensitivity loop 1
Switches 5 and 6 loop 2

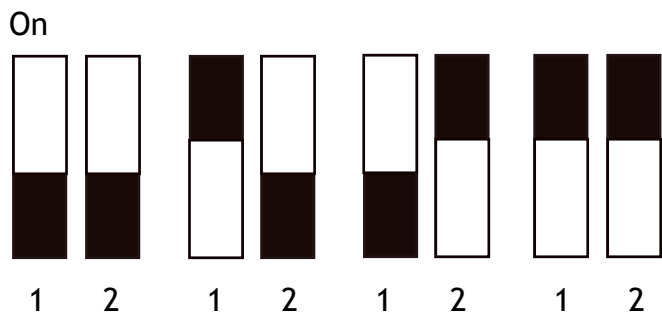

The loop card when used must be activated this is done by changing up to three parameters on the feig controller depending on the application and functionality of the loops to be installed.

P.802 - 0302 This activates the loop card.

P.660 Channel 1 -

P.670 Channel 2 -

23 This activates the safety function of the loop card.

22 This activates the free exit (open signal) from the loop card.

20 Turns the parameter off

If master slave or double leaf the 660 and 670 parameter will need changing on both panels.

In the event of a power failure or electric fault you can manually release the gate and to enable you to be able to open and close the gate by hand.

In order to do this you must first make sure the power has been isolated, then you need to gain access to the control cabinet using the keys supplied and pull the release handle as shown below.



Place the release handle supplied on to the shaft to the side of the gearbox as shown above.

Then turn anti-clockwise to release the gearbox which will allow the gate to free wheel. Then turn the handle clockwise to tighten to put the gate back into automatic.

Make sure you have control of the gate whilst it is in free wheel, the gates are designed to free wheel very easily and can be operated by one person however great care should be taken to ensure no damage is caused when pushing the gate in manual mode. Once you are done turn the red handle lock the motor back in to normal mode.

Note, When powering the gate back up and putting back into use it is advisable to do this when the gate is in the fully opened position so that it knows where it is for its first operation.

Caution - The supplier will take no responsibility for any damage that is caused by misuse of manually using the gate.

| Code | Fault | Remedy |
|------|--------------|---|
| E360 | Closing Edge | Check for 8k2 on edge circuit |
| E380 | Opening Edge | Check for 8k2 on edge circuit |
| E101 | Open Signal | Check open signal connections |
| E102 | Stop Circuit | Check emergency stop and links in board |
| E103 | Close Signal | Check close signal connections |
| E105 | Photocell | Check cells linked out, loop link |
| E101 | Open Signal | Check Access Controls |
| E501 | Loop 1 Error | Check Loop For Continuity |



Fault finding;

| <i>Fault Codes</i> | <i>Operation</i> |
|---------------------------|--------------------------------|
| F700 | Position Fault |
| F030 | Motor stalled |
| F020 | Run Time exceeded |
| F211 | Stop circuit broken |
| F212 | Stop circuit broken |
| F361 | Closing edge over activation |
| F360 | Close edge fault |
| F363 | Close edge open circuit |
| F380 | Open edge Fault/ short Circuit |
| F383 | Close edge open circuit |
| F425 | Over voltage |
| F426 | Under voltage |
| F519 | Motor short circuit |
| F7A2 | Loss of comms |
| F9XX | Board error |

| MECHANICAL ERRORS | CAUSE | CORRECTION |
|---|--|---|
| Gate keeps over running | Limit switches not working | Check both opening/closing limits |
| Gate vibrates when operating | Motor racking set too tight | Adjust motor racking |
| Gate motor not running | Loss of Voltage | Test Motor phase's |
| Gate struggling to move | Motor racking to loose | Adjust motor racking |
| Gate jammed | Rollers Jammed | Check roller channel |
| Gate keeps over running | Limit switches not working | Check both opening/closing limits |
| | | |
| | | |
| ELECTRICAL ERRORS | CAUSE | CORRECTION |
| Blank screen on PLC but power to other devices in the control panel | On-board fuse blown | Replace fuse and reset gate |
| | PLC has developed an electrical fault or had a power spike | Change PLC |
| Gate does not run (stays open) | Check inverter is in ready (rdy) mode on display | Power down then back up |
| | Loop detector is faulting or sensing presence | Clear obstacle or reset the detector |
| | Check inverter settings | see page 13 |
| | Gate staying in the open | Access control giving a constant pulse shorten this |
| | Photo cell batteries (if fitted) | Check that the fitted batteries still have power to them. They should only be replaced with special 3.6V Lithium-ion batteries made for purpose. These can be provided by your supplier |
| | Photo cells dirty (if fitted) | Clean photo cells make sure they are debris free |
| Mains on but no power | Isolator fuse | Check and meter fuse in isolator |
| Gate does not run in either direction | Safety edge fault | Check all safety edges |
| Gate not opening | Access control may be faulty | Remove and check gate function via the PLC |



As stated at the beginning of this manual we recommend a bi-annual service, but at a bare minimum, it is imperative that you get a service done once every 12 months. This is not a sales tactic in disguise, there is a very serious health and safety issue/risk associated with not complying to this. Also in order for your gate to keep complying with the appropriate legislation.

Before carrying out any maintenance to the installation, disconnect the mains power supply.

Make sure you have disconnected/isolated the power before attempting any work.

A Maintenance Contract should be sought from a specialist company after a maximum of 5000 manoeuvres or 1year from the install date.

Occasionally clean the photocell optical components and make sure they are free from dirt, water, rain, soil etc.. ? Batteries in photo cells may need to be changed every 6 months or sooner dependant on use. The gate will not work properly without photo cell function.

Have a qualified technician (installer) check the correct setting of the electric clutch.

If the power supply cable is damaged, it must be replaced by the manufacturer or its technical assistance service, or else by a suitably qualified person, in order to prevent any risk.

When any operational malfunction is found, and not resolved, disconnect the mains power supply and request the assistance of a qualified technician (installer). When automation is out of order, activate the manual release to allow the opening and closing operations to be carried out manually.

Gearbox drive unit is "sealed" for life and requires no further lubrication.

Parts that require lubrication -

The gate has a drive rack that needs lubricated with a DW40 type lubricant.

On a annual service these items mentioned above should be lubricated as well as all other checks listed below.

Checks on a service - All safety edges are operational

All photocells are operational

Limit switched are set correct

Gates are structurally ok e.g no damage

All connections/wiring are ok

All push buttons and stop circuits operate correctly



This Manual **must** be completed in accordance with the guidelines below, **at any point** service/repair work is carried out on the product. This is to achieve two things;

1. To keep a history of the product for yourself and your supplier/manufacturer.
2. To keep an accurate log of any historical or recent modifications, and/or problems, to help an engineer in the event of any future work required on the product.
3. This page is continued on the next page if extra space is needed.

| Date | Reason for visit/Action taken | Engineers Signature |
|-------|-------------------------------|---------------------|
| / /20 | | |
| / /20 | | |
| / /20 | | |
| / /20 | | |
| / /20 | | |
| / /20 | | |
| / /20 | | |
| / /20 | | |
| / /20 | | |
| / /20 | | |
| / /20 | | |
| / /20 | | |
| / /20 | | |
| / /20 | | |
| / /20 | | |
| / /20 | | |
| / /20 | | |
| / /20 | | |
| / /20 | | |

We certify that the system covered by this certificate has been commissioned satisfactorily.

| | | | |
|------------------------|-------|----------------------|--|
| Site Name | | Completion | |
| Site Reference | | Engineers Installing | |
| Installation Commenced | / /20 | Commissioning | |
| Equipment Fitted | | | |
| Handover Date | | | |

Part 2. Existing Installation Items not covered under warranty/ This certificate:

Part 3. Certificate Signing off Section

| | | | |
|-----------------|--|-----------------|--|
| Installers Name | | Signature | |
| On Behalf of | | Date of Signing | |
| Address | | Position | |
| | | | |
| Client Name | | Signature | |
| On Behalf of | | Date of Signing | |
| Site Address | | Position | |
| | | | |



Ultimation Direct Ltd
Unit 14B Telford Drive, Newark, Nottinghamshire. NG24 2DX

Tel: 01636 550300
Email: enquiries@ultimationdirect.co.uk

Declaration of Conformity

In accordance with BS EN ISO/IEC 17050-1:2010

We: Ultimation Direct Ltd

Of: Unit 14B Telford Drive, Newark, Nottinghamshire. NG24 2DX In

accordance with the following directives:-

Machinery Directive: 2006/42/EC

Electromagnetic Compatibility (EMC) Directive 2014/30/EU

The European Radio Equipment Directive 2014/53/EU

Hereby declare that:

Equipment: Automated Sliding Gate

Model no: D5800

Are in conformity with the applicable requirements of the following documents:

2006/42/EC Machinery Directive

BS EN 12453:2017+A1:2021 Industrial, commercial and garage doors and gates—Safety in use of power operated doors— Requirements

BS EN 12604:2017 Industrial, commercial and garage doors and gates—Mechanical aspects—Requirements and test methods

BS EN 13241:2003+A2:2016 Industrial, commercial and garage doors and gates - Product standard. Products without fire re- sistance or smoke control characteristics.

BS-EN12978:2003 Industrial, commercial and garage doors and gates. Safety devices for power operated doors and gates. Requirements and test methods

BS EN 13856-2:2013 Safety of machinery. Pressure sensitive protective devices. General principles for the design and testing of pressure sensitive edges and pressure sensitive bars.

I hereby declare that the equipment named above has been designed to comply with the relevant sections of the above referenced specifications. The unit complies with all applicable Essential Requirements of the Directives.

Signed:

Name: Matthew Mulholland

Position: Technical Director

Place: Newark

Date: March 2024



Specification

Maximum Gate Length: 7.0 metres (depending on height)
 Maximum Gate height: 3.0 metres
 Power Requirement: 230v, Single Phase, 50Hz, 16 Amps
 Drive Motor: 3 Phase motor & wormed gearbox
 Opening/Closing time: 20 seconds (variable)
 Duty Cycle: 100% continuous duty rating
 Finish: Oxy primed and painted in selimix direct

Control: PLC Controlled to suit requirements

Motor/Gearbox

BA 52- 25,03 combination gearbox Motor
 power :- 0.55 kw
 Voltage :- 230-415 V / 3 ph / 50 Hz
 Ratio :- 25 : 1
 Output speed :- 1400 rpm
 Output torque :- 550Nm
 Hollow bore :- 25mm



Made in the UK

