

**DS000** FULL HEIGHT  
TURNSTILE

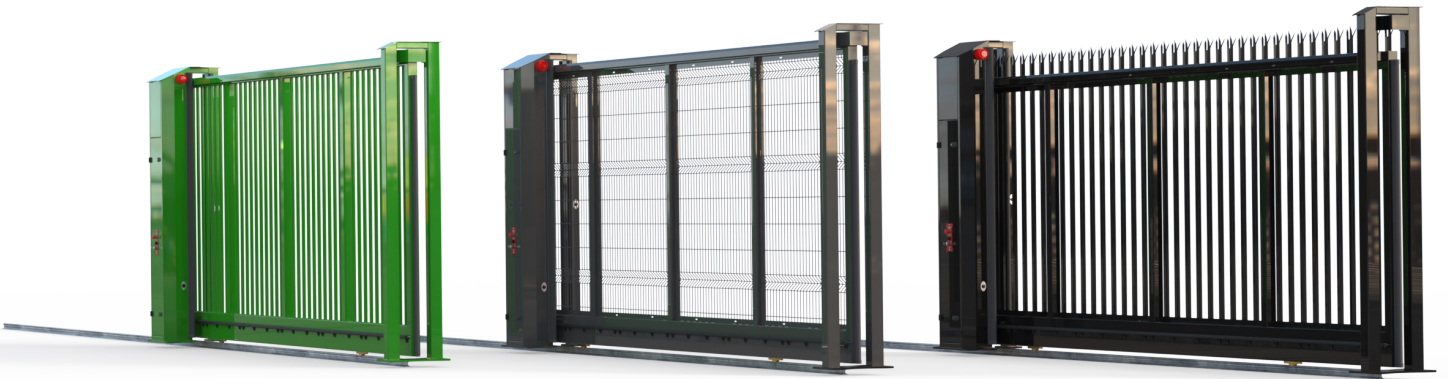

1. Inductions and warnings	Page 03
2. Delivery, Movement and transport	Page 04
3. Lifting and handling	Page 05
4. General layout	Page 06
5. Installation	Page 07
6. Control Panel Layout	Page 17
7. Connection Diagrams	Page 19
8. Front Panel Layout / Usage	Page 23
9. Initial Start Up / Slow Down	Page 24
10. Initial Set-up Walk Through	Page 25
11. Positions Explained	Page 27
12. Auto Close Explained	Page 28
13. Motor / Speed Settings	Page 29
14. Timers / Slow Down Settings	Page 30
15. Manual Release	Page 31
16. Error Codes	Page 32
17. Trouble Shooting	Page 34
18. Maintenance	Page 35
19. Service Log	Page 36
20. Commissioning Certificate	Page 37
21. Declaration Of Conformity	Page 38
22. Technical Data	Page 39

This equipment is part of a large range of traffic flow products. They are designed to be easy to install, as all settings and internal wiring have been completed in our factory. Any of the instructions in this manual should only be carried out by a qualified service engineer or a competent person.

The Gates are ready to bolt down, connect to a single phase power supply and have any pre-cut loops wired into them (Please note that loop detectors are sold separately). The steps must be completed before the power is turned on to prevent accidents.

The following information is a guide only, and whilst we have made every effort to be accurate and correct there may be printing errors which we cannot be held responsible for.

With a correct installation you can expect to enjoy many years of reliable service from this product, we do however recommend that the product has a bi-annual service carried out by a qualified engineer. Please contact our service department to obtain a quote. As we manufacture the products we are best suited to care for your equipment.

## Important Safety Notice



Automatic gates are designed to Control the flow of vehicular traffic only. It can be dangerous to allow the passage of pedestrians and any other self-powered animal or device to utilise this method of access without appropriate warnings and or signage.

It may be necessary for the end user of this product to provide an alternative, safe method of access to cater for the previously mentioned categories.

The end user should fit all necessary signage and warning notices to either side of the gate, which should be visible and clear from all directions of approach.

The product that was shipped to you was designed with a control program to protect all categories from harm or affect this however is only a safety precaution and should not be modified or tampered with by any unauthorised person not sanctioned by the manufacturer.

Please sign and date below to say that you have read and understood this notice before ANY installation work:

/ /20

## Information on using this manual



- ✍ Read all information thoroughly
- ✍ Pay attention to all safety advice
- ✍ Be aware of the symbols (shown above right and above left) as they have different meanings. One is an information symbol, the other a warning.
- ✍ There are many artists impressions of the product in this manual you should refer to the images as a guide only. **Professional CAD** drawings should be used as a reference drawing and nothing else. As before every effort has been made to be 100% accurate in this manual but we cannot make any guarantees.
- ✍ As we constantly innovate our products we may change the quoted spec and any other details that have been documented in this manual so you should always refer to the supplier to see if the manual that was shipped with your product is the latest edition.
- ✍ As with all electrical installations you should use a qualified electrician and obey all of the latest laws and regulations.
- ✍ Be sure to fill out and complete **ALL** paperwork where instructed as this manual is the equipments log book and maintenance manual.

The "Warnings" leaflet and "Instruction booklet" supplied with this product should be read carefully as they provide important information about safety, installation, use and maintenance.

Scrap packing materials (plastic, cardboard, polystyrene etc) according to the provisions set out by current standards. Keep nylon or polystyrene bags out of children's reach.

Keep the instructions together with the technical brochure for future reference.

This product was exclusively designed and manufactured for the use specified in the present documentation. Any other use not specified in this documentation could damage the product and be dangerous.

The Company declines all responsibility for any consequences resulting from improper use of the product, or use which is different from that expected and specified in the present documentation.

Do not install the product in explosive atmosphere.

The construction components of this product must comply with all applicable regulations and subsequent amendments. As for all non-EEC countries, the above mentioned standards as well as the current national standards should be respected in order to achieve a good safety level.

The Company declines all responsibility for any consequences resulting from failure to observe Good Technical Practice when constructing closing structures (door, gates etc.), as well as from any deformation which might occur during use.

The installation must comply with the provisions set out by the applicable regulations and subsequent amendments.

Disconnect the electrical power supply before carrying out any work on the installation. Also disconnect any buffer batteries, if fitted.

Fit an omnipolar or magnetothermal switch on the mains power supply, having a contact opening distance equal to or greater than 3mm.

Check that a differential switch with a 0.03A threshold is fitted just before the power supply mains.

Check that earthing is carried out correctly: connect all metal parts for closure (doors, gates etc.) and all system components provided with an earth terminal.

Fit all the safety devices (photocells, electric edges etc.) which are needed to protect the area from any danger caused by squashing, conveying and shearing, according to and in compliance with the applicable directives and technical standards.

This article describes how your equipment will be delivered to you, specifications on the transportation used and advice including health & safety on movement of the equipment.



The manufacturer will use a qualified transport company to deliver the product conforming to the necessary regulations as detailed below:

- ✘ All drivers are qualified
- ✘ All drivers are tested once yearly ( If applicable )
- ✘ All drivers carry risk assessments and method statements (available on request)
- ✘ They are controlled under law to conform as there are no trade regulation standards to comply with

Health and safety Considerations:

Moving Goods Safely (MGS) is a national project involving both the Health and Safety Executive (HSE) and Local Authorities (LA) working in partnership. The project aims to reduce injuries and ill-health arising from the movement of goods from supplier through haulier to the recipient and end user including any home deliveries. The project will focus upon the delivery and collection of goods and the hazards this generates. It covers the main areas that cause the majority of injuries and ill-health to workers, including:

- ✘ Workplace transport;
- ✘ Slips & trips, and;
- ✘ Musculoskeletal disorders (MSD).

The movement of goods presents us, as health and safety regulators, with the challenge of dealing with a huge variety of issues. The commercial organisations involved within the movement of goods are diverse including haulier, third party logistics providers, pallet networks, retailers etc, with some very large companies, thousands of small businesses and the self-employed. The movement of goods is more than just trucks on the road with a large proportion of accidents happening at the delivery/collection sites that are often not directly under the control of the company making the delivery or collection. Communication and cooperation problems can arise due to the many organizations involved in the movement of the goods, and this can also lead to difficulties in effectively managing health and safety.

(Source H&S Executive UK 2008)

The gates should ALWAYS! be moved with care and attention. The products are very heavy individually as well as a whole. You should not attempt to move this or any other products by unapproved handling methods.



## WARNING

---

Always take safety precautions when lifting and handling heavy objects, in accordance with Manual Handling Operation Regulations 2023.

Always wear correct safety equipment in the vicinity of equipment being off loaded. The gate is to be steadied by means of ropes attached to each end of the gate; preventing it from swinging whilst being manoeuvred. It is important to use the correct nylon slings with a SWL of 2 tonne for each sling.

---

## HANDLING

Due to the size and weight of most D5000 cantilever gates, the use of a mobile crane is required to offload and place into position.

All the D5000 gates come disassembled and each component will require lifting into place. Refer to the installation guide on page 07.

A lifting plan must be done before any attempt to lift the gate into position, As sites vary this must be carried out by the installer prior to the gate being Delivered to site.



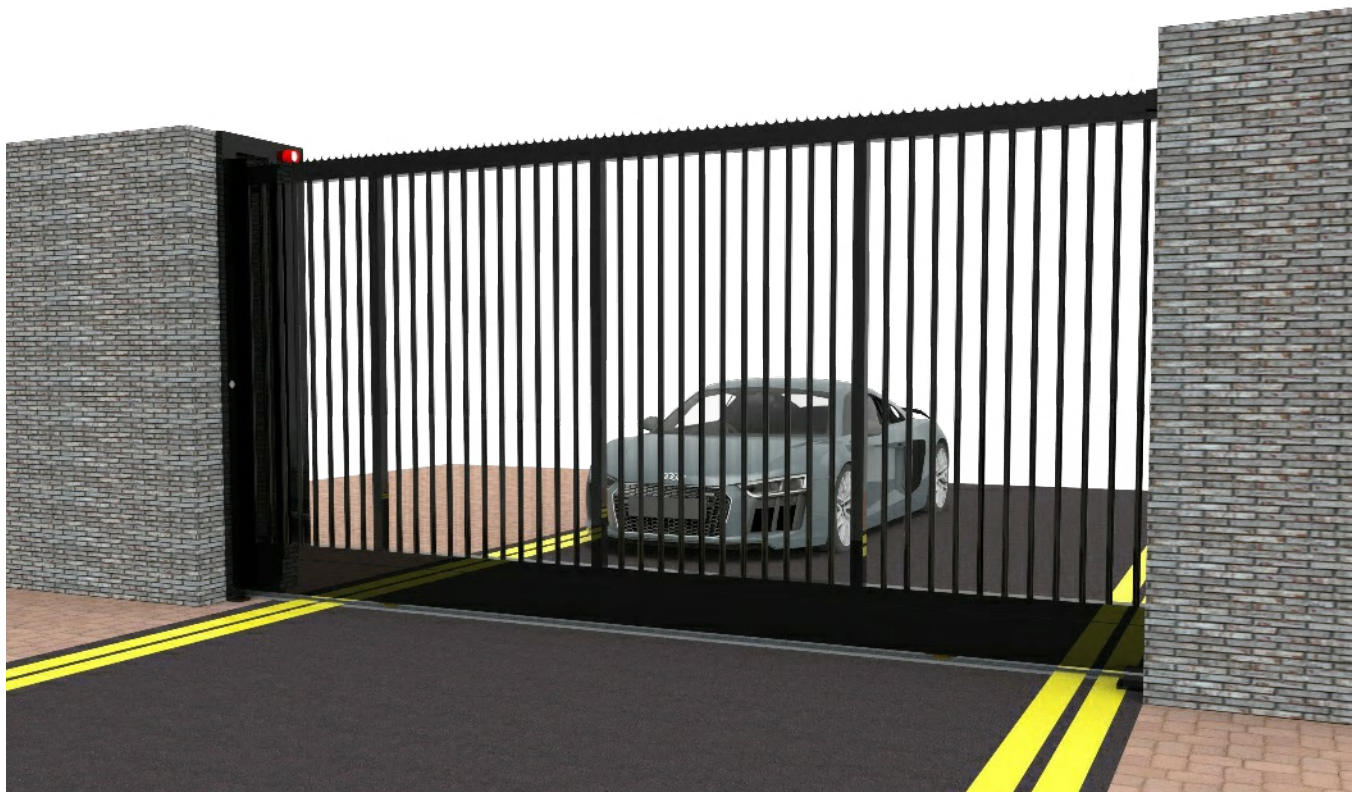
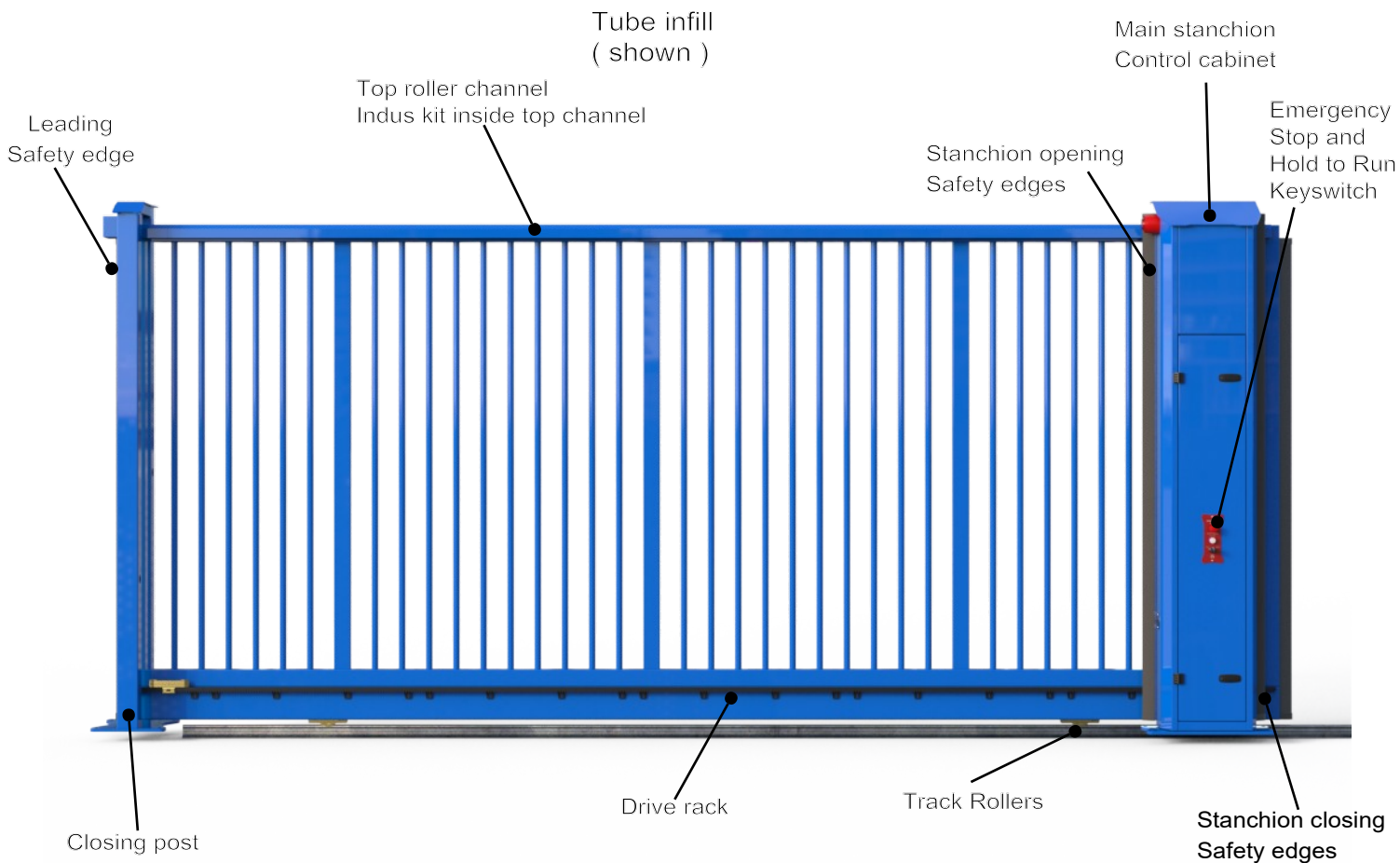

Diagram below shows a typical D5000 sliding gate highlighting the major parts.



## Foundations



All foundations should be installed as per drawing supplied as base size's will vary depending on the size of the gates. (Contact your supplier if you have not been issued one.) All foundations should be installed 10 x days prior to the gates being installed.

If details of the base have not been specified, we recommend a concrete mix to BS EN 206:2013+A2:2013 "Concrete specification, Performance, Production and Conformity" to type C35, which is equally suitable for external and internal environments.

The foundation must be positioned accurately and installed to the correct levels to ensure successful installation.



Careful consideration should be made when deciding the location of the gate to avoid overhead obstructions such as power cables, telephone wires building canopies, trees and other types of likely obstructions and hazards, which will not

---

Note; The main base contains 3 x ducts which require draw ropes to allow for easy access of the cabling to the gate main cabinet.

Duct 1 is connected across the opening to the closing post allowing easy access for the 24v dc to supply power for the photocells.

Duct 2 can be used to supply the mains power cable to the gate cabinet

Duct 3 can then be used as an access point for all access control cabling. Please note these must be all volt free contacts as our panels give +24v dc to receive it back from the access triggers.

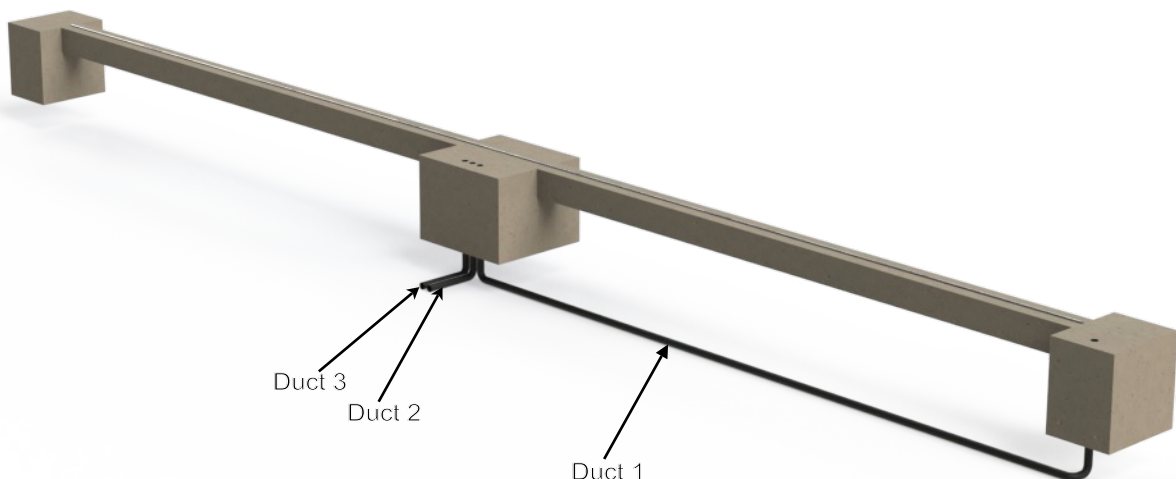

## Fixing Kits;

Once The gate is ready to install Please check through your fixing kit to ensure you have all bolts and accessories required. The Basic fixing kit will include;

- 1, 14 x m16 x 180mm Through bolts
- 2, 3 x m8 x 20mm Button head bolts with washers
- 3, 1 x Catcher
- 4, 1 x Limit Striker ( Open striker fitted )
- 5, 1 x Manual release Key
- 6, 14 x m16 bolt caps
- 7, 1 x operation and Maintenance manual
- 8, 2 x Key switch keys
- 9, 2 x Cabinet keys
- 10, 1 x Indus cable
- 11, 1 x Rear stop
- 12, 1 x Manual release handle

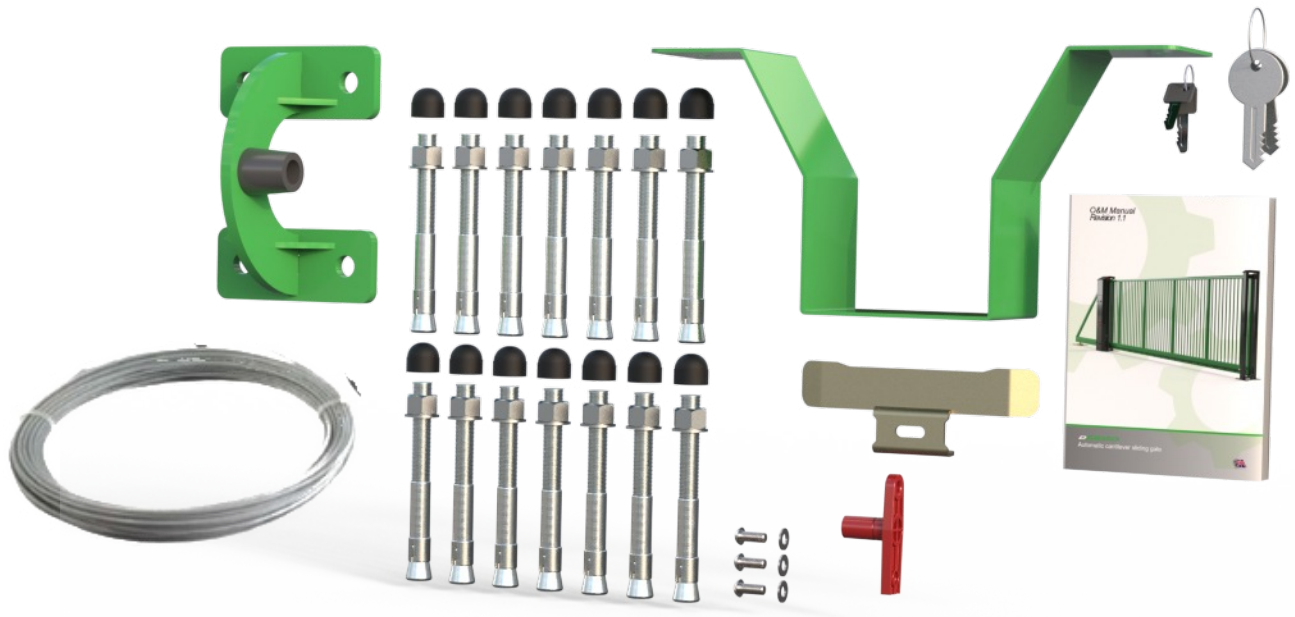

Please note, additional items such as loop detectors, remotes and traffic lights etc can be purchased as extras at the time of quotation or by contacting our spares department and will be issued as extras in your box of fixings.

## Physical Installation.

With the gate lifted into position over the foundation, the following steps should be carefully followed to safely install your new gate.

### Step 1. Lowering the gate onto the foundations.

Before the gate is lowered into position, the surface of the foundation should be swept clean of any particles or contaminants. The position of the incoming ducts to the stanchion should also be measured with reference to the foundation edges to ensure they are exactly as shown on the supplied drawing.

First you must Lower the stanchion on to the main foundation as shown in Fig 1, Whilst lowering the stanchion make sure the Ducts are aligned with the bottom Stanchion hole as shown in fig 2.

Figure 1

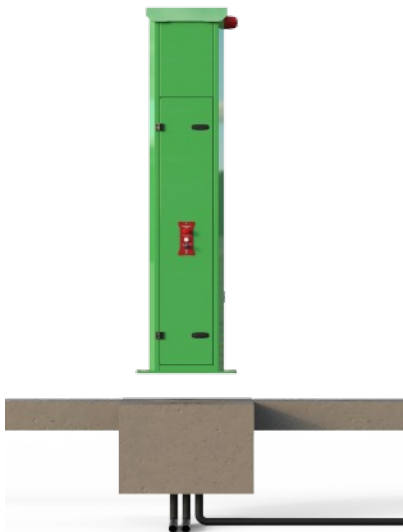

Figure 2



### Step 2 Bolting down the Stanchion.

You must now bolt down the Stanchion, Make sure the stanchion is position correctly So its central to the ground track, see Fig 3. Using your sds with a 16mm bit please drill the 6 x holes in the stanchion and fix to the concrete using our 16mm expansion bolts. These can be tightened to 85nm of torque.

Figure 3

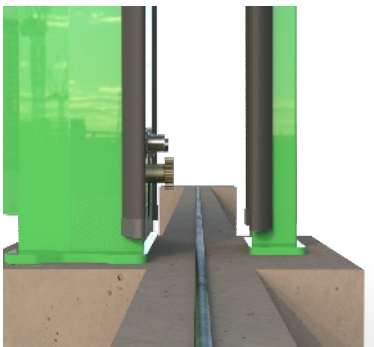
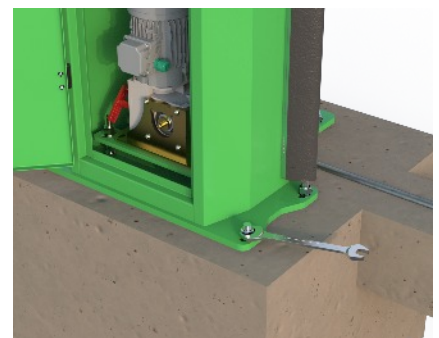

Figure 4



Figure 5



### Step 3 Positioning the Leaf and Aligning the Gate.

Using the attached HIAB crane, Lift the leaf on to the track making sure that the roller wheels are positioned correctly as you set the leaf down. Figure 6.

Figure 6

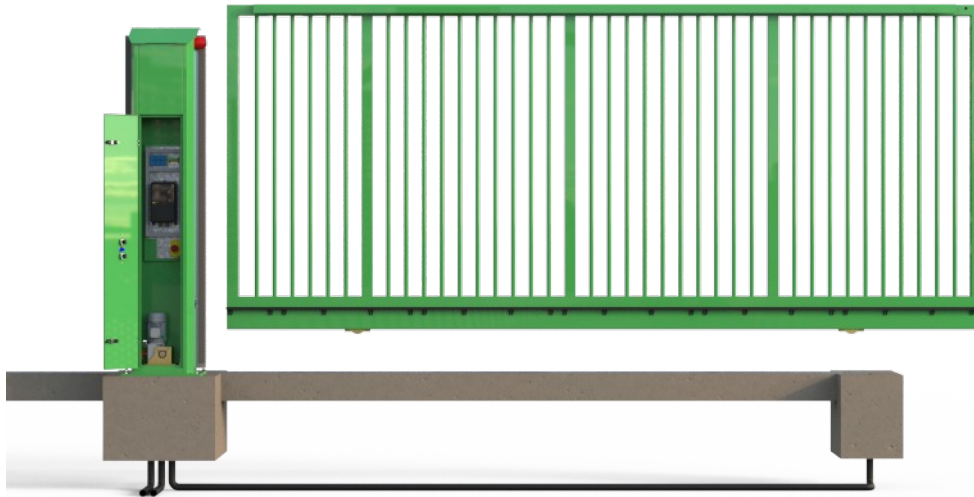

Once the leaf is successfully fitted to the track you can now slide the leaf into the station. Please be careful at this stage as the top guide rollers will need to be located into the guide roller channel to ensure correct operation of the gate.

Figure 7



Figure 8

### Step 3 Positioning the Closing post.

Position the closing post central to the guide track and install using the 16mm sds and anchor bolts. Figure 8. Then tighten the bolts to 85nm of torque to ensure correct fixing is achieved.

Figure 9

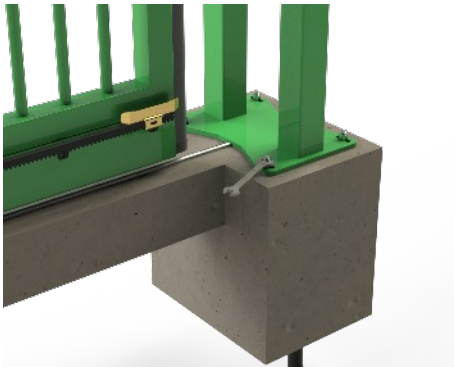

Figure 10

### Step 4 Installing the indus wire

The indus wire will be located inside the box of bits supplied with the gates. Please start by attaching the indus wire to the front part of the indus kit as shown in figure 10. This is held down by a 4mm grub screw which is designed to bite into the indus wire as part of the earthing process.



Figure 11

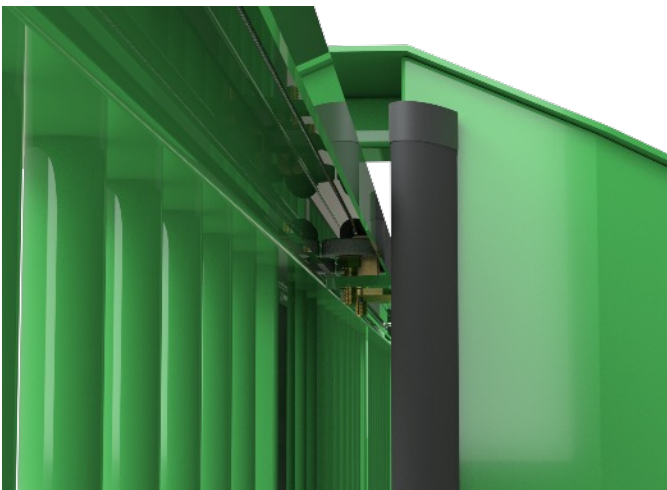

Next please guide the indus wire through the indus coi located behind the station and attach to the rear indus support using the 2.5mm allen key grub screw. Again this is designed to pierce the wire as part of the earthing process.

### Step 5. Connecting The Photocells.

**Note; The photocells are pre wired into two separate channels which allows us to wire both receivers into the gate station and series the photocell contacts into the board before dispatch from our workshop. This in tern makes installation easier as you are only required to send 24v across to the closing post to power the transmitters.**

**Note; The internal photocells are switched to channel 2 by the pink from the receiver and the black cable from the transmitter wired into the positive supply.**

To Connect the photocells Please remove the cover plate from the top centre of the closing post by undoing the 2 x m6 bolts this will require a 4mm Alan key. As shown in figure 12

Once removed you will find 2 x wagos ready to connect your 24v too, This can be achieved by connecting the positive 24v into the wago containing the 2 x brown and 1 x black wires, And the negative 24v into the wago containing the blue wires.

Back at the station this will just be a case of connecting in to the auxiliary 24v supply from our terminal blocks, 12 being positive 24v and 13 being negative 24v. Please see following page.



Figure 12

Step 5 continued;

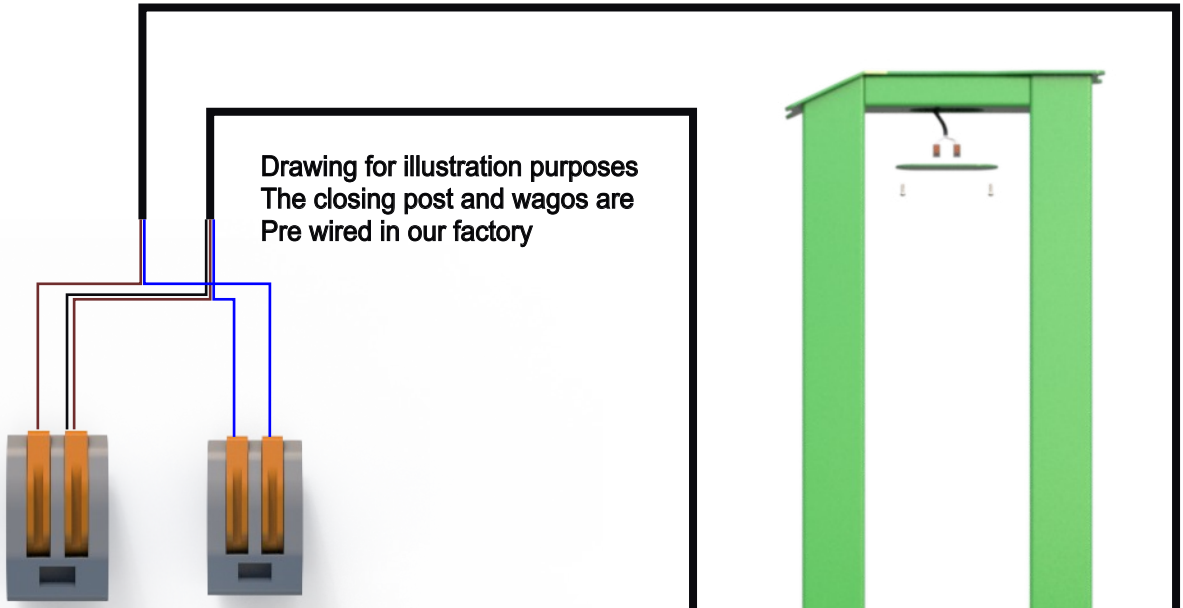

Please note the internal photocell is pre wired to Channel two via the black being added with the Positive connection

The green terminal blocks can be found  
In the gate main station

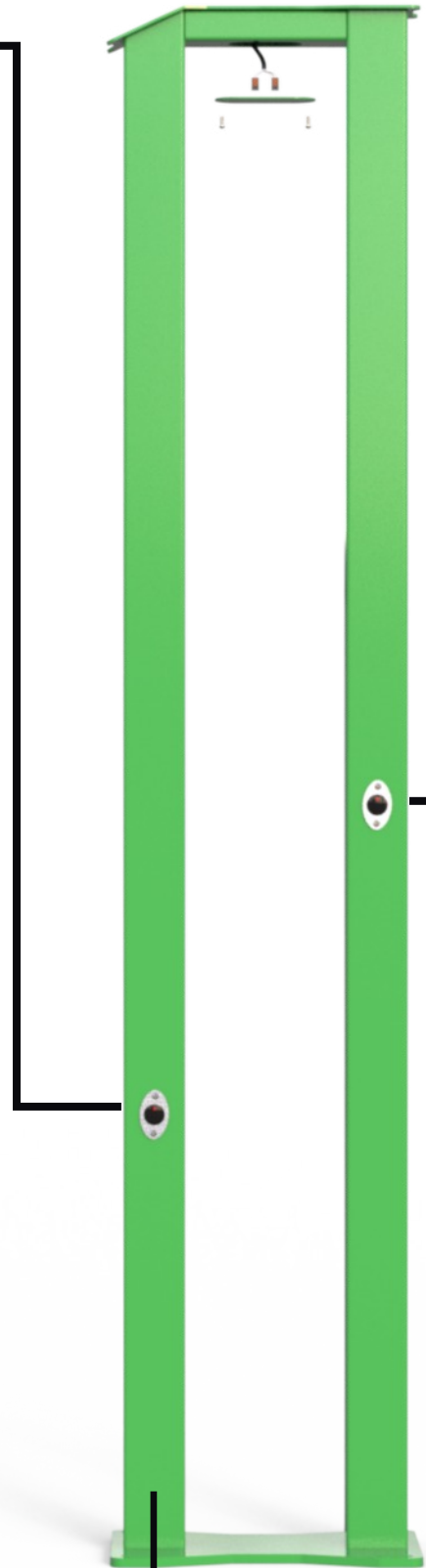
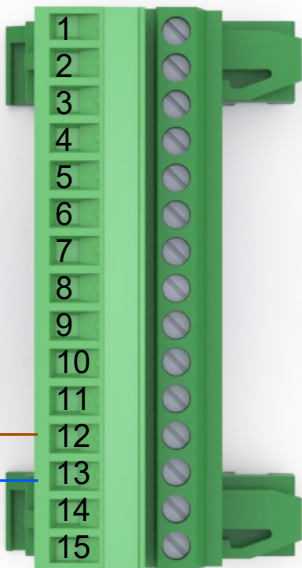

Step 6 Closing post

Figure 13

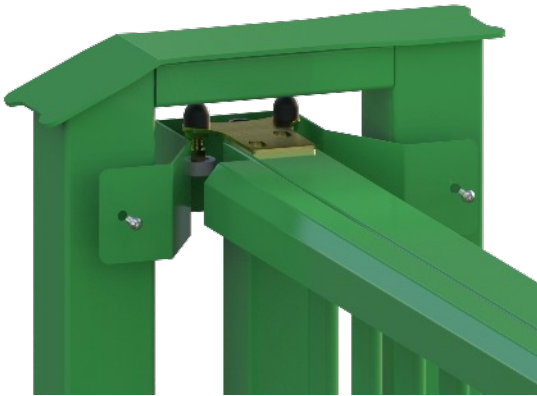

To install the catcher fully close the gate and offer the catcher up to the closing post so that the guide wheels are fully covered by the catcher guide. See figure 13. Please note on a tracked sliding gate this is the closing dead stop and must be fitted to ensure the gate leaf can not travel outside of the station.

Drill the closing post once you have marked the catcher holes with a 7mm hss drill bit this can then be tapped with an 8mm tap and secured using the provided m8 bolts and washers using a 5mm Alan key. See figure 14

Figure 14



The rear stop can be installed as a final part to the installation process this is the dead stop at the rear of the gates travel to ensure the leaf can not travel too far on the track and exit the station. This again can be installed with the 16mm sds and fixed using the 16mm anchor bolts tightened to 85nmn of torque. Figure 15

Figure 15

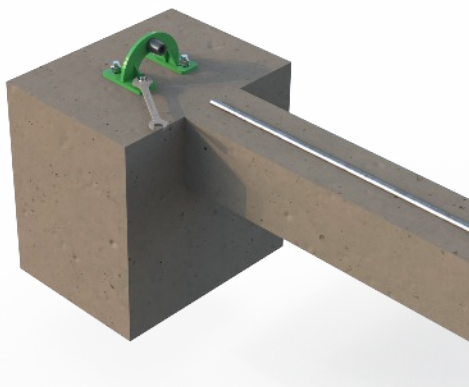

## Step 7 Adjusting the racking

The Drive rack is set in our factory for testing and alignment however. This can become loose or out of alignment due to the transport process. It is therefore the responsibility of the installer to complete the final check to ensure the correct alignment with the drive cog through the full length of the gate.



The best practice for setting this racking is done 1 x section at a time. The m6 hex bolts can be loosened using a 10mm socket and the gate rolled from across the section whilst ensuring the gap stays the same. Once happy with each section the bolts can then be tightened to ensure correct operation of the gate once it is fully automated.

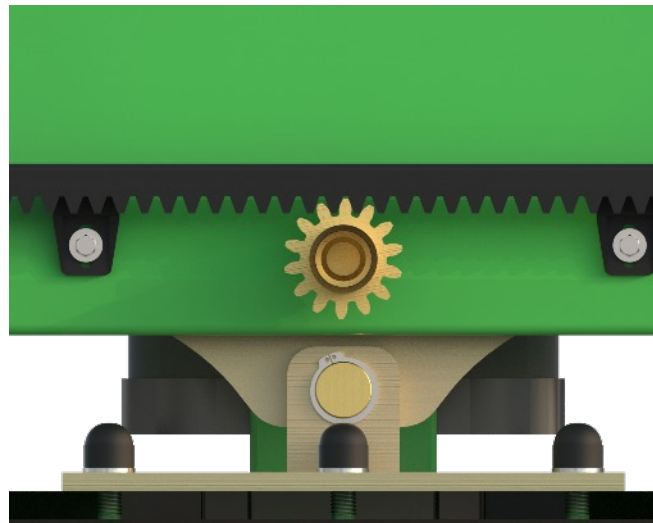

The desired gap between the drive cog and racking is 1 to 2mm for the length of the gate. The Drive rack is supplied with slotted holes to make adjustment easier and should always be done with the gate in manual operation.



Please now lock the motor back in to automated running  
This can be done by turning the red handle located on the side of the motor to engage the drive.

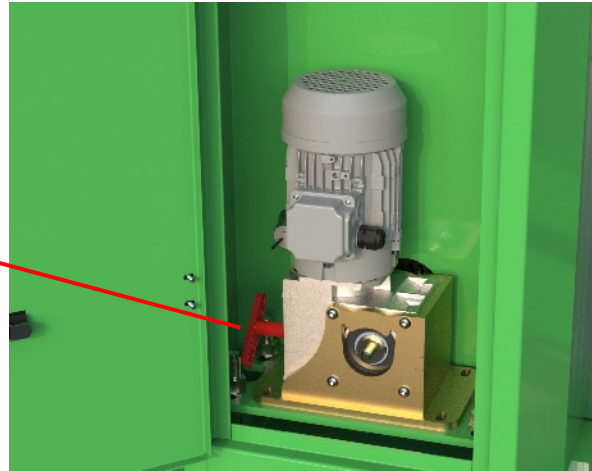

Now that your gate is fully mechanically installed it  
Is now time to connect your mains supply. This is 230 v 16 amp  
single phase supply.

Please Note this supply must be installed and connected  
By a fully qualified electrician and must confirm to BS 7671:2018+A3:2024 and be fully tested  
To ensure minimal earth leakage. As our gates are inverter driven and the inverter  
Itself contains earth leakage filters the supply must be connected  
And tested properly and installed from an mcb as apposed to an rcd.  
Failure to do so could result in improper function of your gate and therefore alter the gates  
Ability to comply with all current regulations.



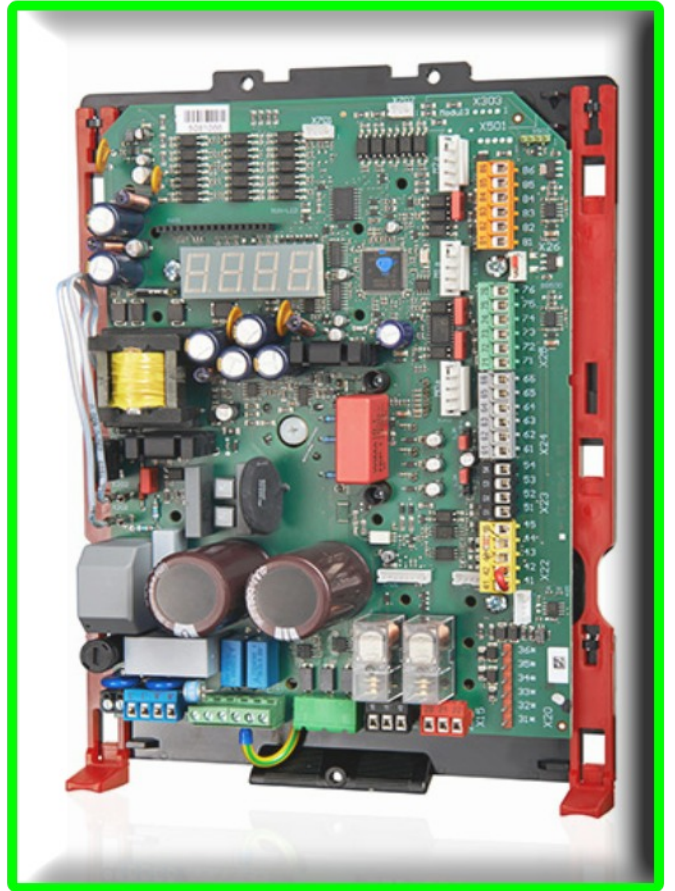

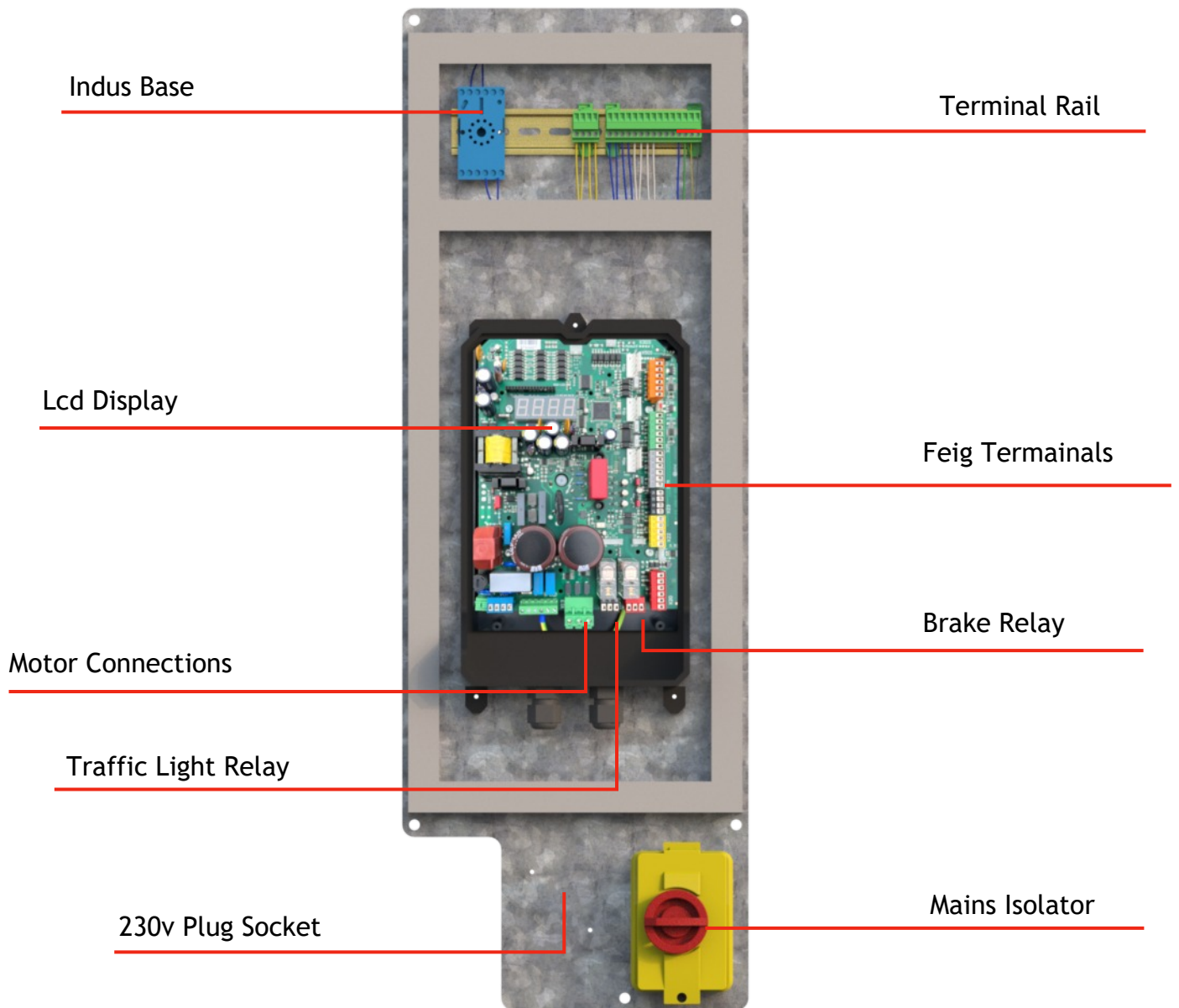

Above shows the layout of a D5000 gate panel which will help identify any main components.



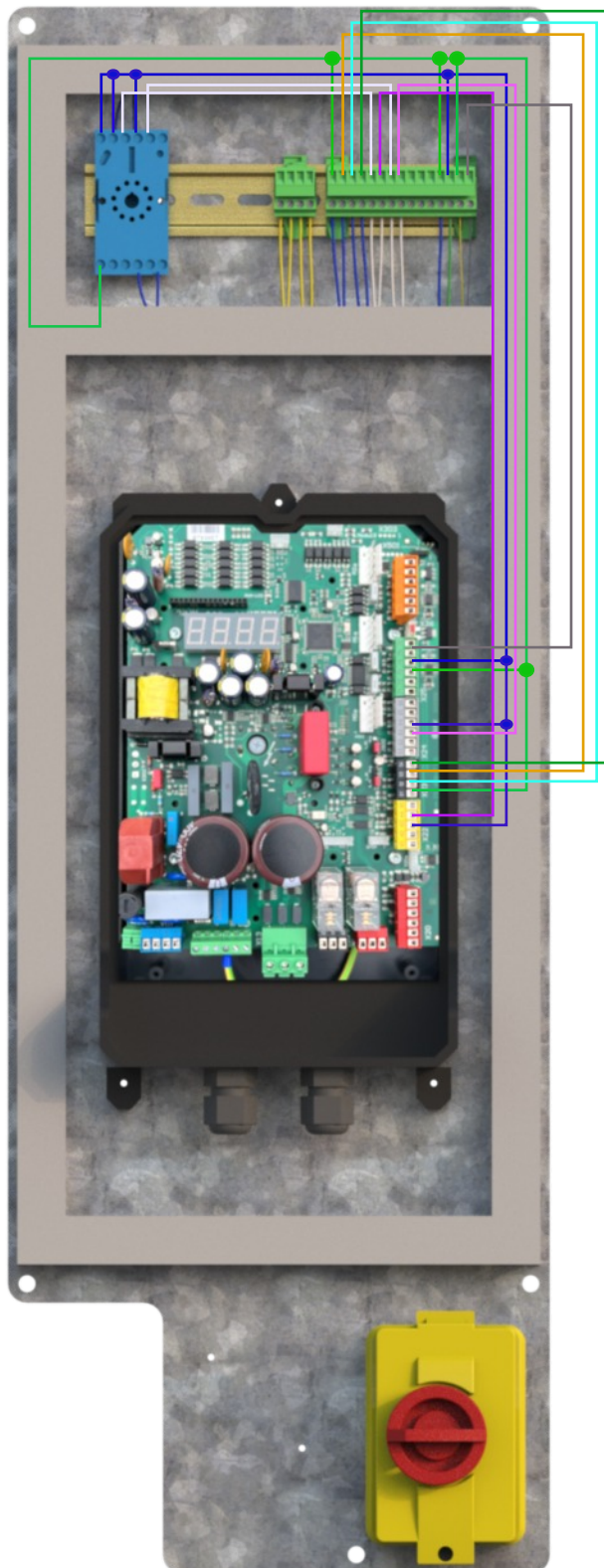

- +24v dc
- -24v dc
- - common for edges
- Close edge
- Open edge
- Photocell
- Stop
- Open
- Close

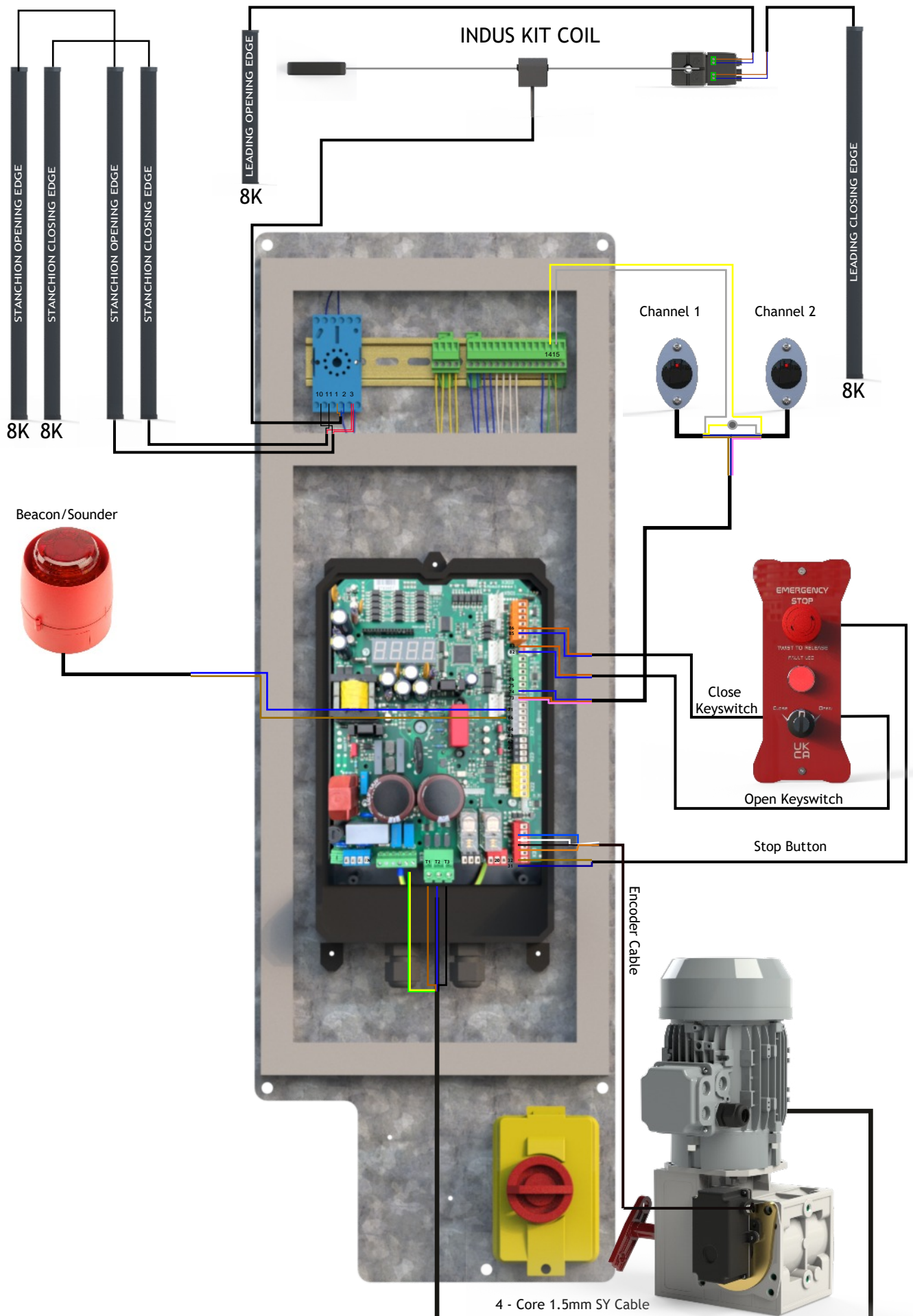

- 86 Common +24v dc
- 85 Open Dead Man
- 84
- 83 Common +24v dc
- 82 Close Dead Man
- 81
- 76 Common
- 75 Photocell
- 74 Ground -24v dc
- 73 Common +24v dc
- 72 Pedestrian Open (Common from 73 if used)
- 71 Ground -24v dc (Common for opening edge)
- 66 Beacon Sounder (common from 71)
- 65 Open Edge 8k2 Input ( common from 71)
- 64
- 63 Ground -24v dc
- 62 Common +24v dc
- 61
- 54 Close Input
- 53 Stop Input (link from 51 if not used)
- 52 Open input
- 51 Common +24v
- 45
- 44 Ground -24v (Common for Close Edge)
- 43 Close Edge Input (Common from 44)
- 42 Common +24v dc
- 41 Stop Input (Link from 42 if not used)
- 36 Ground
- 35 Channel B
- 34 Channel A
- 33 +12v
- 32 Common +24v dc
- 31 Stop input (Link from 32 if not used)
- 22
- 21 +24v dc Link from power supply if mag requested
- 20 Maglock Positive feed
- 12 Green Traffic Light +24v dc
- 11 +24v dc Link
- 10 Red Traffic Light +24v dc

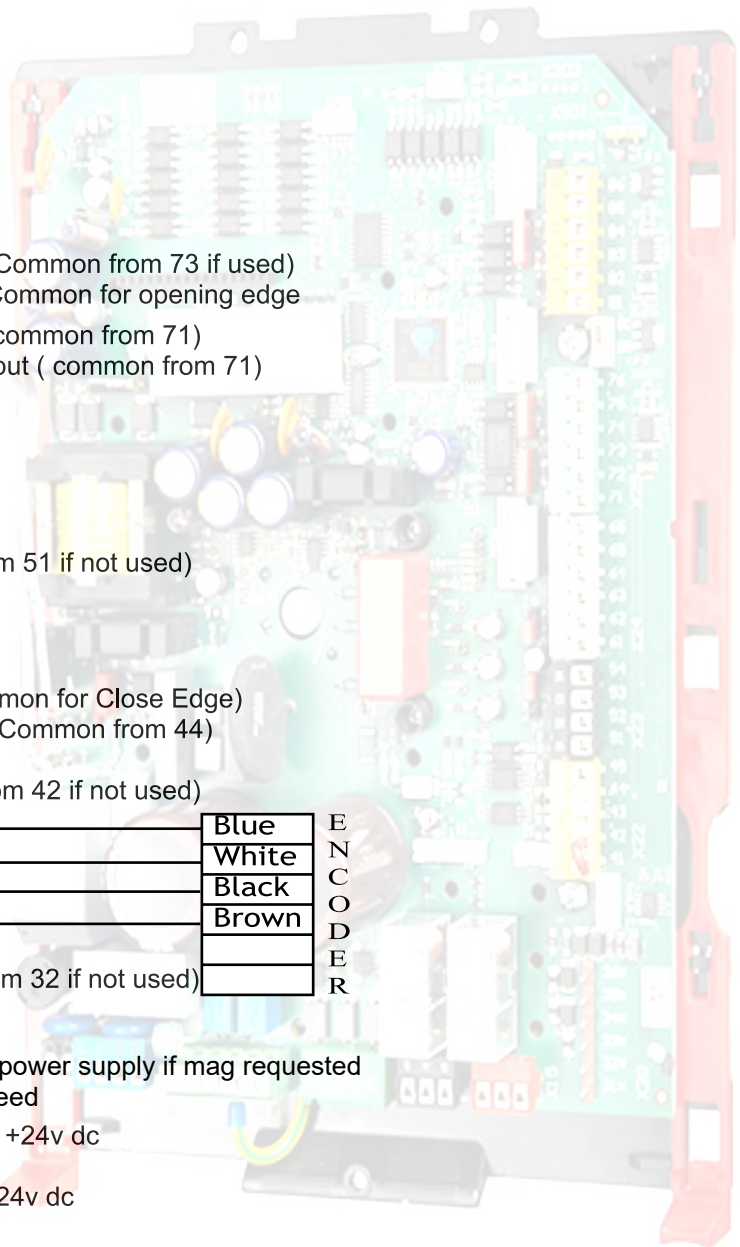

36	Ground	Blue	E
35	Channel B	White	N
34	Channel A	Black	C
33	+12v	Brown	O
32	Common +24v dc		D
31	Stop input (Link from 32 if not used)		E
			R

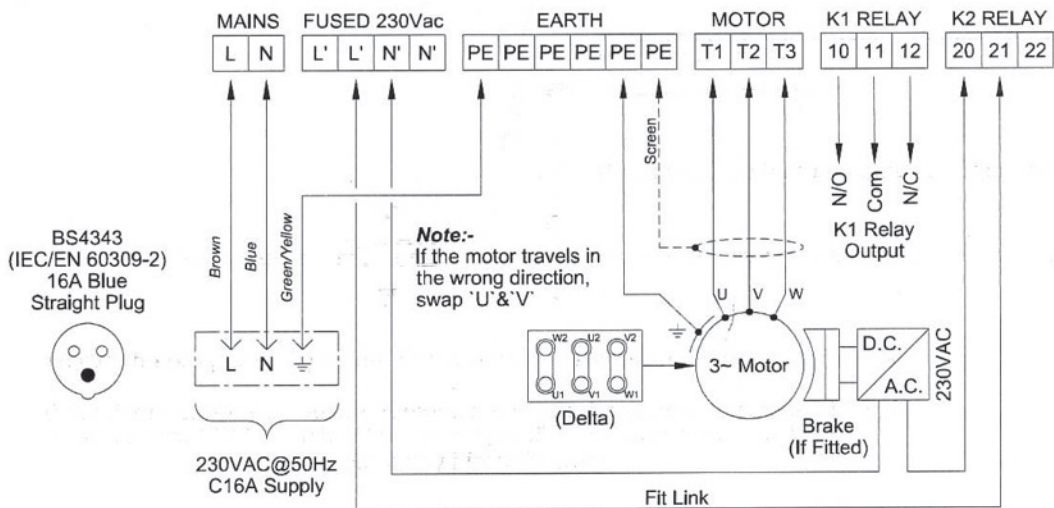

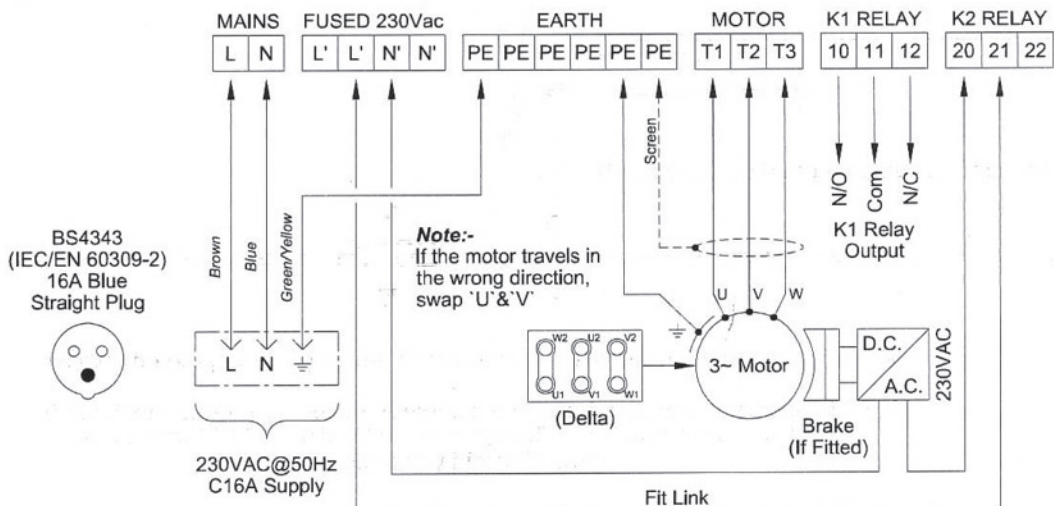
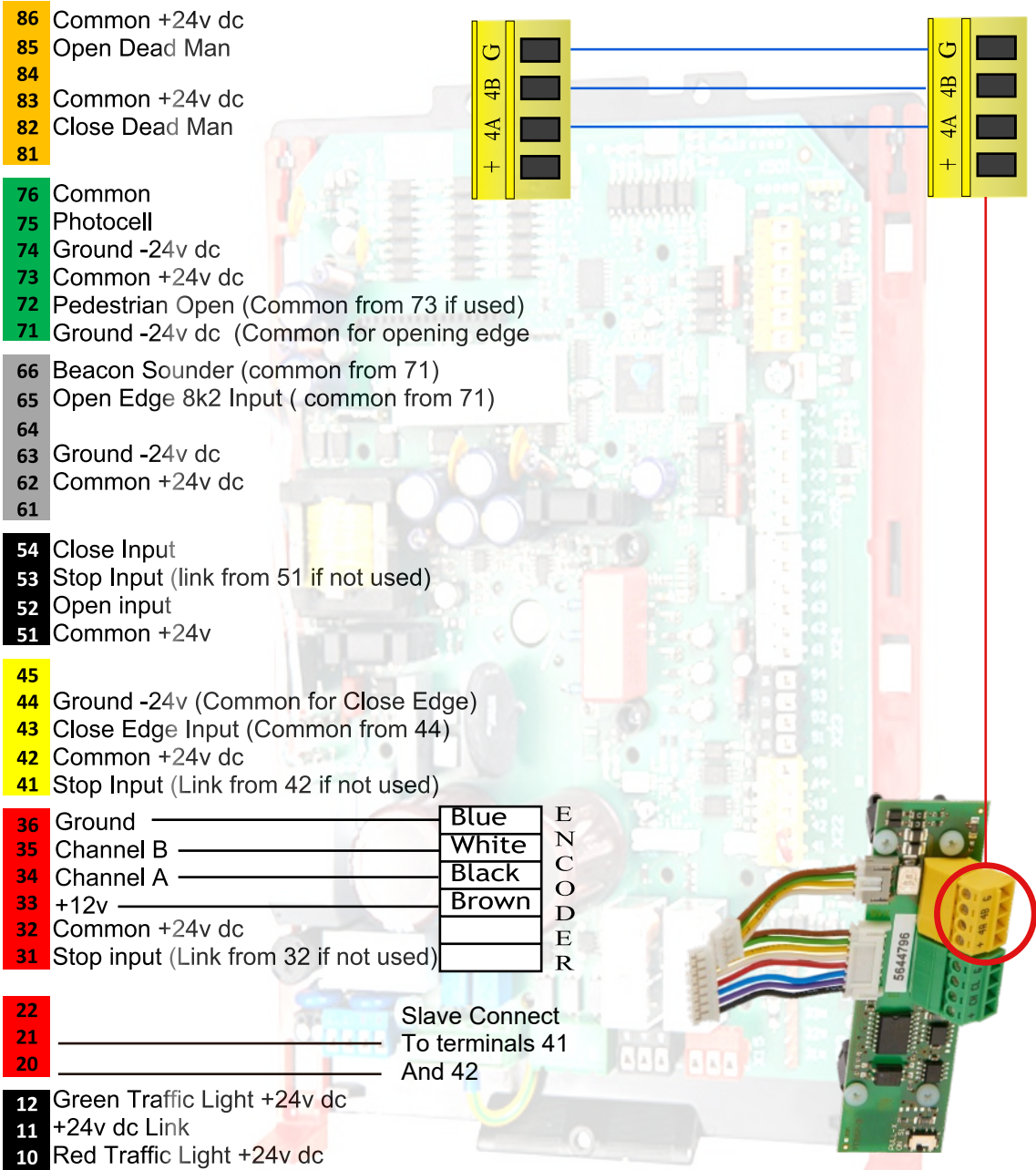

- A. Loop Channel 1
- A. Loop Channel 1
- B. Loop Channel 2
- B. Loop Channel 2
- 1. Common +24v dc
- 2. Stop N/C
- 3. Open N/O
- 4. Close N/O
- 5. Open Edge In
- 6. Open Edge Out
- 7. Close Edge In
- 8. Close Edge Out
- 9. Free
- 10. Free
- 11. Free
- 12. +24v dc (For slave photocells)
- 13. -24v dc (For slave photocells)
- 14. Photocell common (yellow)
- 15. Photocell contact (Grey)

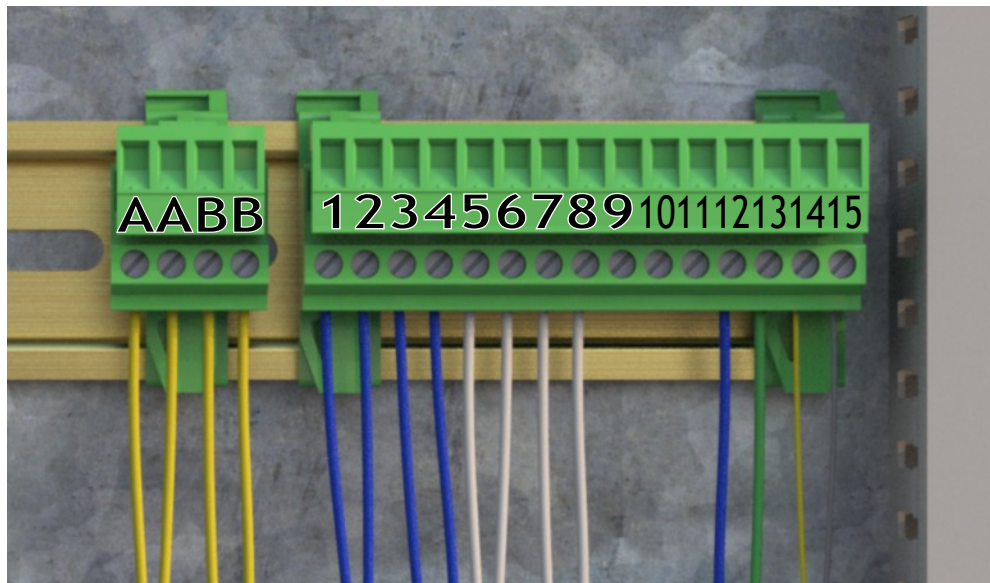

**Safety and Auto loop bases**

We now use the feig plug in loop cards for convenience of the engineer. If ordered with the product this will arrive with tails pre wired into the green terminal strip.

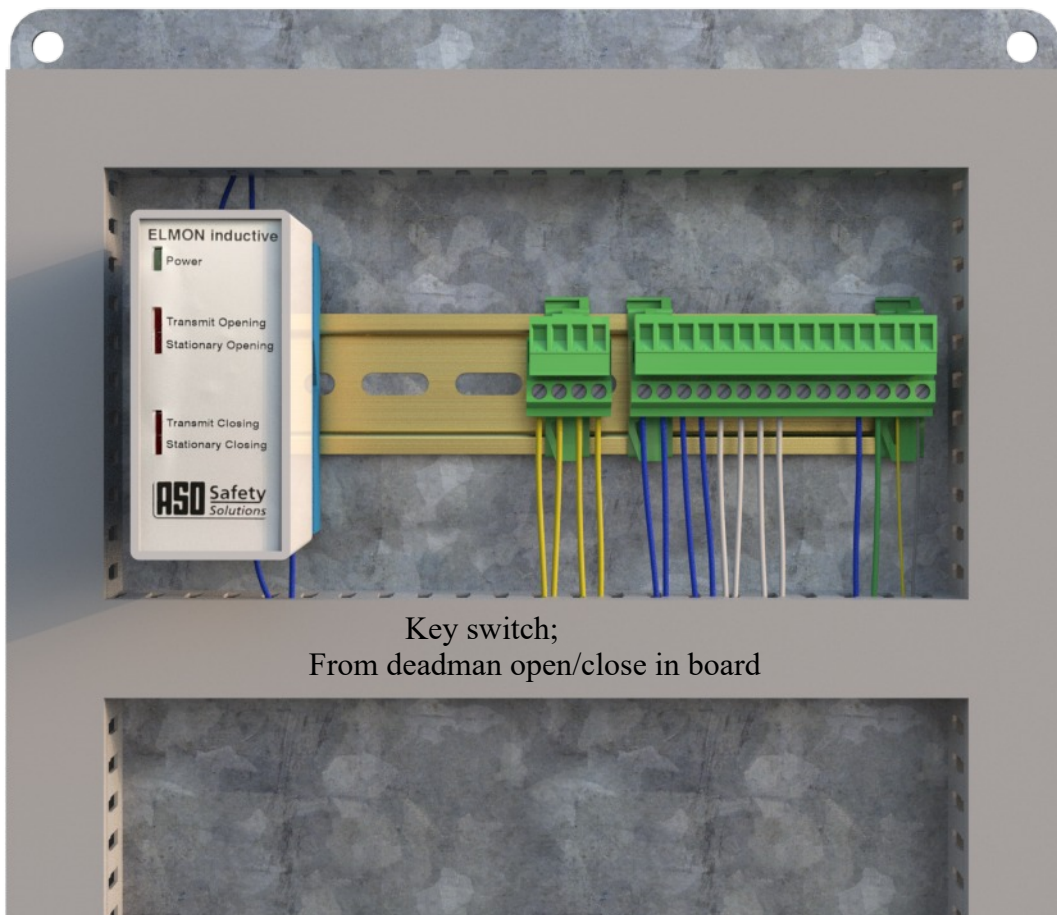

Key switch;  
From deadman open/close in board

At the front of the control cabinet you will find our fully labelled door control unit this incorporates the emergency stop button which when pressed will over ride all gate functions and keep the gate stationary where activated. This can be released with a slight twist to allow operation of the gate.

In addition you can find our open / close key switch which also works with our emergency dead man function.

Please note in the event of a safety device failure the gate incorporates a dedicated deadman function.

The gate can be operated via the hold to run key switch located on the cabinet door panel simply hold in the direction you would like the gate to operate



Emergency Stop

Hold to Run/Activation Key Switch

**Guide to inputs Commonly Used,**

P.100	50HZ	Motor Frequency
P.101	1.7A	Motor Current
P.102	74%	Motor Cos
P.103	230V	Motor Voltage
P.205	0800	Encoder Setting
P.202	10	Resolution/ Increments of Travel Allowed
P.216	1	Slow positions Pre-set
P.222	300	Close Slow Position
P.223	300	Open Slow Position
P.310	30HZ	Open Speed
P.312	100	Acceleration Open HZ per second
P.320	10HZ	Open Slow Speed
P.322	15	Open Ramp
P.332	500	Deceleration After Opening Edge Activation
P.350	30HZ	Close Speed
P.352	100	Acceleration Close HZ per second
P.360	10HZ	Close Slow Speed
P.362	15	Close Ramp
P.372	500	Deceleration After Close Edge Activation
P.420	3	Pause Time on Safe Edge Reversal M/S
P.70F	0801	Output 15 Set to Beacon Sounder

**Closing Edge,**

P.460	1	8K2 Edge
P.467	16	Reverse Increments During Closing according to P.4xB
P.4DB	400	Reversal Increments

**Opening Edge,**

P.5A0	14	Input 10 Safety A
P.5A1	10	Reverse Increments During Opening according to P.4xB
P.5A2	2	Input 10 8K2
P.4AB	400	Reversal Increments

When you have the gate powered and ready to run please follow the next few steps to initially set up your encoder run positions. This will only need setting once.

---

Figure 1

**Step 1;**

Once powered up provided there are no faults the board will display the message Cali, this is asking you to calibrate the encoder. Figure 1

**Step 2;**

When ready press the stop button briefly. The board will now display The EI-EC asking you to sync to close position. Note the dots between the letters will be flashing.

---

Figure 3

**Step 3;**

Simply hold the down arrow to close the gate to its desired position, don't worry if you let go early simply press the down to jog the gate to position. Once at your desired close position press and hold the stop until the dots stop flashing this will record the close position and then revert to the open sync, Figure 4

**Step 4;**

Please now using the up arrow move the gate to its desired open position. Again once happy press and hold the stop button until the dots stop flashing to store the open position.

**Step 5;**

The gate is now set and ready to operate, before testing safeties I would advise at this point to give the gate an open and close operation to ensure the positions are correct and you can see the slow downs and ramps operating correctly.



**Step 6,**

If you are now happy with the gates positions please test all safeties as normal, i. e all edges and photocells. The gate also now incorporates a force detection this will require a firm push to the leaf to enable its operation whilst the leaf is travelling. The leaf once force detected will move to its opposite position and stop. If The gate positions need resetting please follow the following few steps to re calibrate the encoders.

---

**Step 7,**

Should we need to reset the positions on the gate please follow these steps.

You will need to access the parameters menu. This can be done by pressing and holding the stop and up arrows together. See figure 6

Figure 6

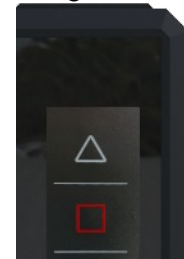
**Step 8,**

Navigate through the menu to parameter 999 (figure 7) using the up arrows. (Note holding the down arrow and pressing the up will move through parameters in blocks of ten for ease)

Figure 7

**Step 9,**

Once at P999 press and the stop button this will enter the parameter allowing you to change the value. Please set this to number 3 using the up arrows and confirm by holding the stop again for 2 seconds. Figures 8 and 9) to exit the parameter just press the stop key.

Figure 8

**Step 10,**

Now navigate through the menu to parameter 210 and set this to 5, this will reset the encoder allowing you to re calibrate the gate. Please follow previous steps until you are happy with the positions and safeties.

---

**Note This setup is the same for single leaf and master and slave. The buttons will only work the leaf to which they are installed. To test both leaves on a bi parting gate, (double leaf) please use the open and close inputs on the board.**

**Position set up;**

Should your gate run out of travel during the set up process then you will need to alter the P202 Parameter this is pre set to 8, any alterations made will double the increments of travel so 9 will be double 8, 10 will be double 9 and so on. Common practice is to have P202 set to the minimum amount achievable. The board has a maximum of around 3000 increments of travel. To alter follow the instructions previously shown to access the full menu, You will Then be able to access the 202 parameter. If in doubt the gates travel can be checked with parameter 230. This will give you the full travel increments of the gate ideally we are looking for this to be around 2000 for your pre set slow downs to be at a good distance.

3000	Increments of travel close	0
0	Increments of travel open	3000

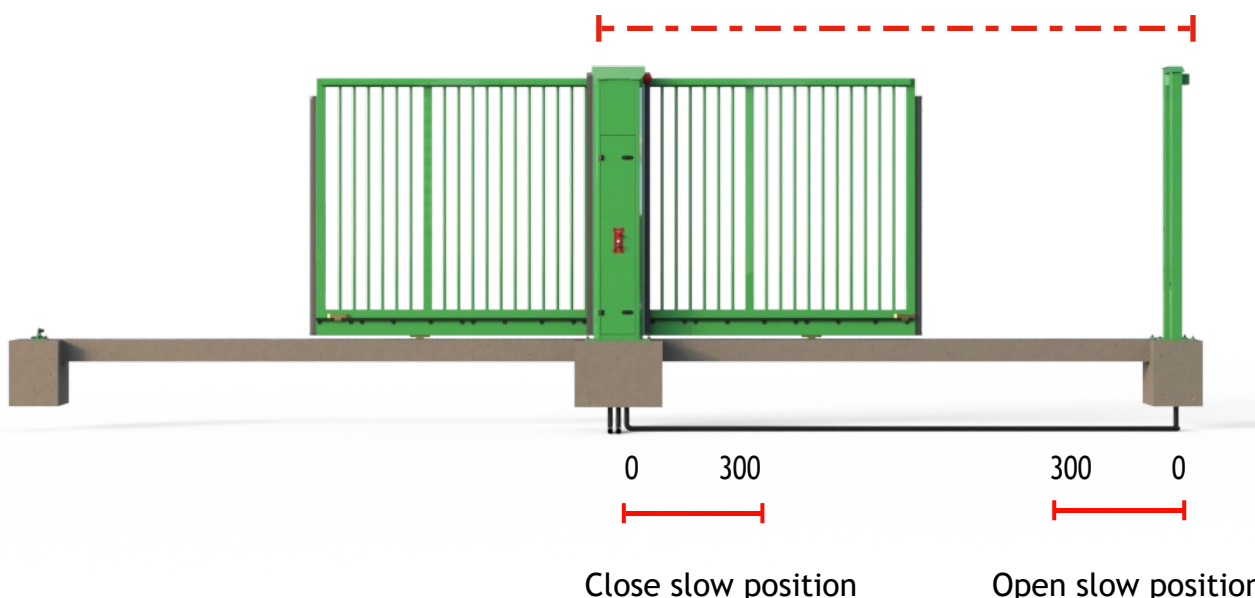

**Slow down set up;**

To adjust the slow down positions Please access P222 for close slow down and P232 for open Slow down. These parameters are pre set too 300 increments from there respective limits, Therefore to reduce the slow distance 300 would be reduced for example to 200, to increase Please add to the slow down so 300 would become 400 as an example.

### Auto close options explained;

The auto close functions can be accessed through the parameters menu, For the no passage timer P010 can be easily accessed without having to access the full menu, As standard this is pre set to 30 seconds. This can be altered to your desired time in seconds, should you wish to turn this Parameter off simply set the timer to 0 which will turn the timer off.

Loop / Photocell close, To adjust the loop photocell close there are a few settings which govern this parameter. The full menu will need to be accessed, once this has been done You will need to navigate to P4B7 this parameter will be set to 0 which is off, should you Wish to turn this on set 4B7 to 2 which will enable the parameter.

Now the photo close is active we have a couple more options to add a delay to the photo close P025 can be adjusted to allow this however a delay here will also delay all close commands Therefore should you wish to give the gate a close command via access controls and this input not be delayed P535 will need to be set to 0. This will disable the timer on the close input command



Within the panels display you are able to set the speeds of the drive to enable you to fine tune the gate drive as per site requirements.

Select parameter code P999, Press 3 to unlock the menu to gain access to the below drive settings.

<i>Motor Code</i>	<i>Operation</i>	<i>Frequency</i>
P310	Opening Speed	Hz
P320	Opening Slow Speed	Hz
P322	Opening Ramp	Hz per second
P350	Close Speed	Hz
P360	Close Slow Speed	Hz
P362	Closing Ramp	Hz per second
P312	Open Acceleration	Hz per second
P352	Close Acceleration	Hz per second
P222	Close slow position	In Increments Of travel
P232	Open slow position	In increments of travel

Should you encounter any errors or make a mistake whilst programming you can enter the full programming menu, Go to parameter 990 and set to number 2 which will reset the panel to our initial programme as factory set.

Note: when a safety edge is activated the drive will automatically back off in it's quickest possible time. You can also use the slow speed setting to alter your force test results if needed.



To set the timers on the feig board follow the instructions to access the full parameters 999 set to 3, The timers can then be adjusted as follows to suit sites requirements. Please note with timers and parameters setting them to the 0 position will turn the timer off.

Parameter	Description	Timers
P010	No Passage Timer	30
P020	Open Delay Timer	0
P025	Close Delay Timer	0
P712	Traffic Light Delay	0

Customisable parameters, bellow is a list of parameters and functions that are offered with the control board please note the feig controller does not have a built in time clock. These can be supplied on request and programmed to suit site requirements.

Parameter	Description	Values
P000	Cycle Counter	Full Gate Cycle
P005	Maintenance Counter	Counter Set Between Service Periods
P920	Error Log	Last 8 Errors
P925	Software Version	Current Software Version
P985	Language	0 = English
P232	Open Slow Down	In Increments Of Travel
P222	Close Slow Down	In Increments Of Travel
P582	Normally Closed Limits	0 = On 1 = Off
P487	Safety Close	0 = Off 2 = On
P501	2 Step Logic	0204

The loop board can be added to your Feig controller as per the diagram these simply push in for ease and allow easy control for single or dual channel.

**L.E.D Indications**

- Green fast flash - Detector Tuning
- Green Solid Light - Detector is ready
- Green and Red on - Loop detecting
- Red Solid Light - Loop Fault

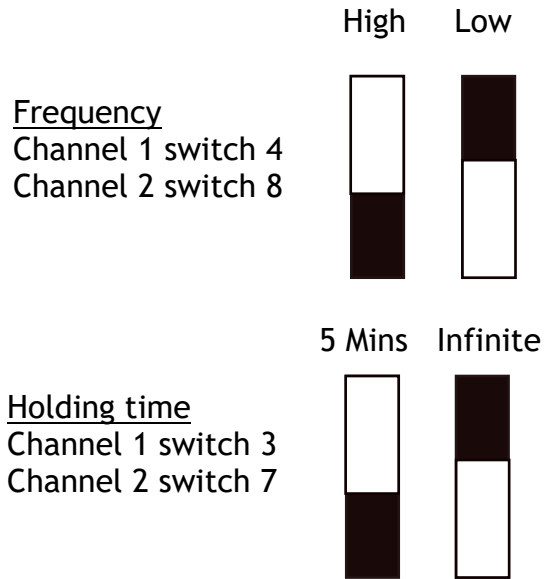
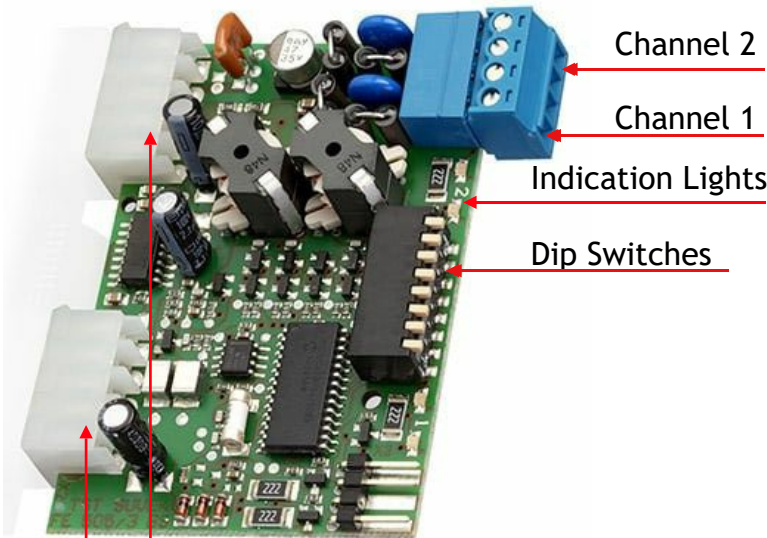

Dip switches 1 and 2 for sensitivity loop 1  
Switches 5 and 6 loop 2

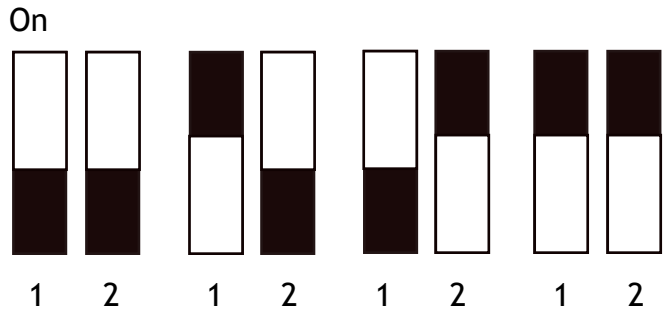

The loop card when used must be activated this is done by changing up to three parameters on the feig controller depending on the application and functionality of the loops to be installed.

- P.802 - 0302 This activates the loop card.
- P.660 Channel 1 -
- P.670 Channel 2 -
- 23 This activates the safety function of the loop card.
- 22 This activates the free exit (open signal) from the loop card.
- 20 Turns the parameter off

If master slave or double leaf the 660 and 670 parameter will need changing on both panels.

In the event of a power failure or electric fault you can manually release the gate and to enable you to be able to open and close the gate by hand.

In order to do this you must first make sure the power has been isolated, then you need to gain access to the control cabinet using the keys supplied and pull the release handle as shown below.



Place the release handle supplied on to the nut on the gearbox as shown above.

Then turn anti-clockwise to loosen the nut which will allow the gate to free wheel. Then turn the handle clockwise to tighten to put the gate back into automatic.

Make sure you have control of the gate whilst it is in free wheel, the gates are designed to free wheel very easily and can be operated by one person however great care should be taken to ensure no damage is caused when pushing the gate in manual mode. Once you are done turn the red handle lock the motor back in to normal mode.

Note, When powering the gate back up and putting back into use it is advisable to do this when the gate is in the fully opened position so that it knows where it is for its first operation.

**Caution** - The supplier will take no responsibility for any damage that is caused by misuse of manually using the gate.

Code	Description	Reason
E000	Open pressed Membrane	
E050	Stop pressed Membrane	
E090	Close pressed Membrane	
E101	Open input	Open activated
E102	Stop input	Stop activated
E103	Close input	Close activated
E104	Ped open Input	Ped activated
E105	Photocell input	Photocell activated
E106	Dead open input	Deadman open activated
E107	Dead close input	Deadman close activated
E108	Open limit input	Open limit activated
E109	Close limit input	Close limit activated
E110	Input 10	Open safety input loss of 8k
E201	Membrane stop pressed	
E211	E-stop	Terminals 41/42 open
E212	E-stop	Terminals 31/32 open
E360	Close edge input	Terminals 43/44 open
E363	Close edge resistance	Terminals 43/44 no 8k
E380	Open edge input	Terminals 63/65 open
E383	Open edge resistance	Terminals 63/65 no 8k
E501	Loop detector channel 1	Channel 1 active
E502	Loop detector channel 2	Channel 2 active

Code	Description	Fault / Rectification
F000	Traveled Past calibrated open	Check Speeds/ Encoder Slip / Re-calibrate
F005	Traveled Past Calibrated open	Check Speeds/ Encoder slip / Re-calibrate
F020	Run Time exceeded	Check P410/P415/P419
F030	Lag Error	Check Boost settings P.140 / P.145
F031	Moving wrong direction	Channel A/B reversed. Recalibrate p210
F211	E-Stop	Terminals 41/42
F212	E-Stop	Terminals 31/32
F325	Obstacle During Closing	Adjust force detection settings
F360	Closing edge activated	Edge detected terminals 43/44
F363	Interruption closing edge	Check for 8k input
F380	Open edge activated	Edge detected terminal 63/65
F383	Interruption open edge	Check for 8k input
F425	Overvoltage Supply	Incoming mains voltage too high
F426	Undervoltage Supply	Incoming mains voltage too low
F430	Heat sink temp out	Power stage too high
F515	Motor Overcurrent	Boost settings too high, P140/P145
F700	Position Unknown	Calibration not set or recalibrate P210 to 5
F752	Loss of Comms with Encoder	Interface cable defective/No 12v supply
F766	Encoder Error	Re-calibrate P210-5
F76A	Encoder Magnetic Field	Re-fit magnet further into encoder
F7A2	Expansion Board error	Loss of comms master/slave
F930	External watchdog error	Moisture on board / Hardware error

MECHANICAL ERRORS	CAUSE	CORRECTION
Gate keeps over running	Limit switches not working	Check both opening/closing limits
Gate vibrates when operating	Motor racking set too tight	Adjust motor racking
Gate motor not running	Loss of Voltage	Test Motor phase's
Gate struggling to move	Motor racking to loose	Adjust motor racking
Gate jammed	Rollers Jammed	Check roller channel
Gate keeps over running	Limit switches not working	Check both opening/closing limits
ELECTRICAL ERRORS	CAUSE	CORRECTION
Blank screen on PLC but power to other devices in the control panel	On-board fuse blown	Replace fuse and reset gate
	PLC has developed an electrical fault or had a power spike	Change PLC
Gate does not run (stays open)	Check inverter is in ready (rdy) mode on display	Power down then back up
	Loop detector is faulting or sensing presence	Clear obstacle or reset the detector
	Check inverter settings	see page 13
	Gate staying in the open	Access control giving a constant pulse shorten this
	Photo cell batteries (if fitted)	Check that the fitted batteries still have power to them. They should only be replaced with special 3.6V Lithium-ion batteries made for purpose. These can be provided by your supplier
	Photo cells dirty (if fitted)	Clean photo cells make sure they are debris free
Mains on but no power	Isolator fuse	Check and meter fuse in isolator
Gate does not run in either direction	Safety edge fault	Check all safety edges
Gate not opening	Access control may be faulty	Remove and check gate function via the PLC



As stated at the beginning of this manual we recommend a bi-annual service, but at a bare minimum, it is imperative that you get a service done once every 12 months. This is not a sales tactic in disguise, there is a very serious health and safety issue/risk associated with not complying to this. Also in order for your gate to keep complying with the appropriate legislation.

Before carrying out any maintenance to the installation, disconnect the mains power supply.

Make sure you have disconnected/isolated the power before attempting any work.

A Maintenance Contract should be sought from a specialist company after a maximum of 5000 manoeuvres or 1 year from the install date.

Occasionally clean the photocell optical components and make sure they are free from dirt, water, rain, soil etc.. ? Batteries in photo cells may need to be changed every 6 months or sooner dependant on use. The gate will not work properly without photo cell function.

Have a qualified technician (installer) check the correct setting of the electric clutch.

If the power supply cable is damaged, it must be replaced by the manufacturer or its technical assistance service, or else by a suitably qualified person, in order to prevent any risk.

When any operational malfunction is found, and not resolved, disconnect the mains power supply and request the assistance of a qualified technician (installer). When automation is out of order, activate the manual release to allow the opening and closing operations to be carried out manually.

Gearbox drive unit is "sealed" for life and requires no further lubrication.

Parts that require lubrication -

The gate has a drive rack that needs lubricated with a DW40 type lubricant.

On a annual service these items mentioned above should be lubricated as well as all other checks listed below.

Checks on a service -

- All safety edges are operational
- All photocells are operational
- Limit switched are set correct
- Gates are structurally ok e.g no damage
- All connections/wiring are ok
- All push buttons and stop circuits operate correctly



This Manual **must** be completed in accordance with the guidelines below, **at any point** service/repair work is carried out on the product. This is to achieve two things;

1. To keep a history of the product for yourself and your supplier/manufacturer.
2. To keep an accurate log of any historical or recent modifications, and/or problems, to help an engineer in the event of any future work required on the product.
3. This page is continued on the next page if extra space is needed.

Date	Reason for visit/Action taken	Engineers Signature
/ /20		
/ /20		
/ /20		
/ /20		
/ /20		
/ /20		
/ /20		
/ /20		
/ /20		
/ /20		
/ /20		
/ /20		
/ /20		
/ /20		
/ /20		
/ /20		
/ /20		
/ /20		

We certify that the system covered by this certificate has been commissioned satisfactorily.			
Site Name		Completion	
Site Reference		Engineers Installing	
Installation Commenced	/ /	Commissioning	
Equipment Fitted			
Handover Date			

Part 2. Existing Installation Items not covered under warranty/ This certificate:

--	--	--	--

Part 3. Certificate Signing off

Installers Name		Signature	
On Behalf of		Date of Signing	
Address		Position	
Client Name		Signature	
On Behalf of		Date of Signing	
Site Address		Position	

Part 4. Onsite training for product usage

Trainers Name,	Date	Competency / Job Title	Signature
Attendees Name	Date	Signature to confirm understanding	



Ultimation Direct Ltd  
Maltkiln Lane, Newark, Notts, NG24 1HN

Tel: 01636 550300  
Email: enquiries@ultimationdirect.co.uk

## Declaration of Conformity

In accordance with BS EN ISO/IEC 17050-1:2010

**We:** Ultimation Direct Ltd

**Of:** Trent Lane, Maltkiln lane, Newark, Notts NG24 1HN In

accordance with the following directives:-

Supply of Machinery (Safety) Regulations 2008

Electromagnetic Compatibility Regulations 2016

The Radio Equipment Regulations 2017

Hereby declare that:

**Equipment:** Automated Sliding Gate

**Model no:** D5000

Are in conformity with the applicable requirements of the following documents:

Supply of Machinery (Safety) Regulations 2008.

BS EN 12453:2017+A1:2021 Industrial, commercial and garage doors and gates—Safety in use of power operated doors— Requirements.

BS EN 12604:2017 Industrial, commercial and garage doors and gates—Mechanical aspects—Requirements and test methods.

BS EN 13241:2003+A2:2016 Industrial, commercial and garage doors and gates - Product standard. Products without fire resistance or smoke control characteristics.

BS-EN12978:2003 Industrial, commercial and garage doors and gates. Safety devices for power operated doors and gates. Requirements and test methods.

BS EN 13856-2:2013 Safety of machinery. Pressure sensitive protective devices. General principles for the design and testing of pressure sensitive edges and pressure sensitive bars.

I hereby declare that the equipment named above has been designed to comply with the relevant sections of the above referenced specifications. The unit complies with all applicable Essential Requirements of the Regulations.

Signed:

A handwritten signature in black ink, appearing to read 'Matthew Mulholland', is written over a horizontal line.

Name: Matthew Mulholland

Position: Technical Director

Place: Newark

Date: March 2026

The UKCA logo consists of the letters 'UK' stacked above the letters 'CA' in a bold, black, sans-serif font.

**Specification**

Maximum Gate Length: 14 metres (depending on height)  
 Maximum Gate height: 3.0 metres  
 Power Requirement: 230v, Single Phase, 50Hz, 16 Amps  
 Drive Motor: 3 Phase motor & wormed gearbox  
 Opening/Closing time: 3.6 seconds per metre at 50hz (variable)  
 Duty Cycle: 100% continuous duty rating  
 Finish: Oxy primed and painted in selimix direct

Control: Feig control panel

**Motor/Gearbox**

BA 52- 25,03 combination gearbox Motor  
 power :- 0.55 kw  
 Voltage :- 230-415 V / 3 ph / 50 Hz  
 Ratio :- 15 : 1  
 Output speed :- 1400 rpm  
 Output torque :- 550Nm  
 Hollow bore :- 25mm



**Made in the UK**

