

060001 SEMI AUTOMATIC
SWING GATE



OM MANUAL



1. Inductions and Warnings	Page 03
2. Delivery, Movement and Transport	Page 04
3. Lifting and Handling	Page 05
4. Layout/Description	Page 06
5. Pre Installation Checks	Page 07 - 08
6. Installation Guide	Page 09 - 14
7. Terminal Lists	Page 15 - 16
8. Terminal Rail	Page 17
9. Control Panel Layouts	Page 18 - 20
10. Stanchion Diagrams	Page 21 - 23
11. Ancillary Wiring	Page 24 - 25
12. Initial Set Up	Page 26 - 27
13. Initial Parameters	Page 28
14. Manual Release	Page 29
15. Maintenance	Page 30
16. Trouble Shooting Guide	Page 31 - 32
17. Commissioning Certificate	Page 33
18. Service Log	Page 34
19. Declaration of Conformity	Page 35
20. Technical Data	Page 36

This equipment is part of a large range of traffic flow products. They are designed to be easy to install, as all settings and internal wiring have been completed in our factory. Any of the instructions in this manual should only be carried out by a qualified service engineer or a competent person.

The Gates are ready to bolt down, connect to a single phase power supply and have any pre-cut loops wired into them (Please note that loop detectors are sold separately). The steps must be completed before the power is turned on to prevent accidents.

The following information is a guide only, and whilst we have made every effort to be accurate and correct there may be printing errors which we cannot be held responsible for.

With a correct installation you can expect to enjoy many years of reliable service from this product, we do however recommend that the product has a bi-annual service carried out by a qualified engineer. Please contact our service department to obtain a quote. As we manufacture the products we are best suited to care for your equipment.

Important Safety Notice



Automatic gates are designed to Control the flow of vehicular traffic only. It can be dangerous to allow the passage of pedestrians and any other self-powered animal or device to utilise this method of access without appropriate warnings and or signage.

It may be necessary for the end user of this product to provide an alternative, safe method of access to cater for the previously mentioned categories.

The end user should fit all necessary signage and warning notices to either side of the gate, which should be visible and clear from all directions of approach.

The product that was shipped to you was designed with a control program to protect all categories from harm or affect this however is only a safety precaution and should not be modified or tampered with by any unauthorised person not sanctioned by the manufacturer.

Please sign and date below to say that you have read and understood this notice before ANY installation work:

/ /20

Information on using this manual



- ✍ Read all information thoroughly
- ✍ Pay attention to all safety advice
- ✍ Be aware of the symbols (shown above right and above left) as they have different meanings. One is an information symbol, the other a warning.
- ✍ There are many artists impressions of the product in this manual you should refer to the images as a guide only. **Professional CAD** drawings should be used as a reference drawing and nothing else. As before every effort has been made to be 100% accurate in this manual but we cannot make any guarantees.
- ✍ As we constantly innovate our products we may change the quoted spec and any other details that have been documented in this manual so you should always refer to the supplier to see if the manual that was shipped with your product is the latest edition.
- ✍ As with all electrical installations you should use a qualified electrician and obey all of the latest laws and regulations.
- ✍ Be sure to fill out and complete **ALL** paperwork where instructed as this manual is the equipments log book and maintenance manual.

The "Warnings" leaflet and "Instruction booklet" supplied with this product should be read carefully as they provide important information about safety, installation, use and maintenance.

Scrap packing materials (plastic, cardboard, polystyrene etc) according to the provisions set out by current standards. Keep nylon or polystyrene bags out of children's reach.

Keep the instructions together with the technical brochure for future reference.

This product was exclusively designed and manufactured for the use specified in the present documentation. Any other use not specified in this documentation could damage the product and be dangerous.

The Company declines all responsibility for any consequences resulting from improper use of the product, or use which is different from that expected and specified in the present documentation.

Do not install the product in explosive atmosphere.

The construction components of this product must comply with all applicable regulations and subsequent amendments. As for all non-EEC countries, the above mentioned standards as well as the current national standards should be respected in order to achieve a good safety level.

The Company declines all responsibility for any consequences resulting from failure to observe Good Technical Practice when constructing closing structures (door, gates etc.), as well as from any deformation which might occur during use.

The installation must comply with the provisions set out by the applicable regulations and subsequent amendments.

Disconnect the electrical power supply before carrying out any work on the installation. Also disconnect any buffer batteries, if fitted.

Fit an omnipolar or magnetothermal switch on the mains power supply, having a contact opening distance equal to or greater than 3mm.

Check that a differential switch with a 0.03A threshold is fitted just before the power supply mains.

Check that earthing is carried out correctly: connect all metal parts for closure (doors, gates etc.) and all system components provided with an earth terminal.

Fit all the safety devices (photocells, electric edges etc.) which are needed to protect the area from any danger caused by squashing, conveying and shearing, according to and in compliance with the applicable directives and technical standards.

This article describes how your equipment will be delivered to you, specifications on the transportation used and advice including health & safety on movement of the equipment.



The manufacturer will use a qualified transport company to deliver the product conforming to the necessary regulations as detailed below:

- ✘ All drivers are qualified
- ✘ All drivers are tested once yearly (If applicable)
- ✘ All drivers carry risk assessments and method statements (available on request)
- ✘ They are controlled under law to conform as there are no trade regulation standards to comply with

Health and safety Considerations:

Moving Goods Safely (MGS) is a national project involving both the Health and Safety Executive (HSE) and Local Authorities (LA) working in partnership. The project aims to reduce injuries and ill-health arising from the movement of goods from supplier through haulier to the recipient and end user including any home deliveries. The project will focus upon the delivery and collection of goods and the hazards this generates. It covers the main areas that cause the majority of injuries and ill-health to workers, including:

- ✘ Workplace transport;
- ✘ Slips & trips, and;
- ✘ Musculoskeletal disorders (MSD).

The movement of goods presents us, as health and safety regulators, with the challenge of dealing with a huge variety of issues. The commercial organisations involved within the movement of goods are diverse including haulier, third party logistics providers, pallet networks, retailers etc, with some very large companies, thousands of small businesses and the self-employed. The movement of goods is more than just trucks on the road with a large proportion of accidents happening at the delivery/collection sites that are often not directly under the control of the company making the delivery or collection. Communication and cooperation problems can arise due to the many organizations involved in the movement of the goods, and this can also lead to difficulties in effectively managing health and safety.

(Source H&S Executive UK 2008)

The gates should ALWAYS! be moved with care and attention. The products are very heavy individually as well as a whole. You should not attempt to move this or any other products by unapproved handling methods.



WARNING

Always take safety precautions when lifting and handling heavy objects, in accordance with Manual Handling Operation Regulations 2022.

Always wear correct safety equipment in the vicinity of equipment being off loaded. The gate is to be steadied by means of ropes attached to each end of the gate; preventing it from swinging whilst being manoeuvred. It is important to use the correct nylon slings with a SWL of 2 tonne for each sling.

HANDLING

Due to the size and weight of most D6000I Swing gates, the services of a mobile crane/ hiab are essential for safe off-loading and positioning. Depending on the size of the gates they may come as one assembly and will need lifting of the Lorry as one complete unit, The strapping point is around the top hinge plate. Once strapped and ready to lift off the lorry you must make sure you have a rope attached to the gate to control the potential swinging of the gate while in the Air, Once the gate is safely on the base you can then proceed to the installation, make sure you do not unstrap the gate until you have fixed the post down. If the Gates are delivered in separate components then you will need to lift the posts off first to allow you to bolt them down, then while you have the use of the crane you can lift the gates straight on to the posts.

Note, If the gate frames have been delivered and strapped on a Transport frame, the Haulier will need to return this to the factory or you could be liable for any charges incurred for the return of the frame.

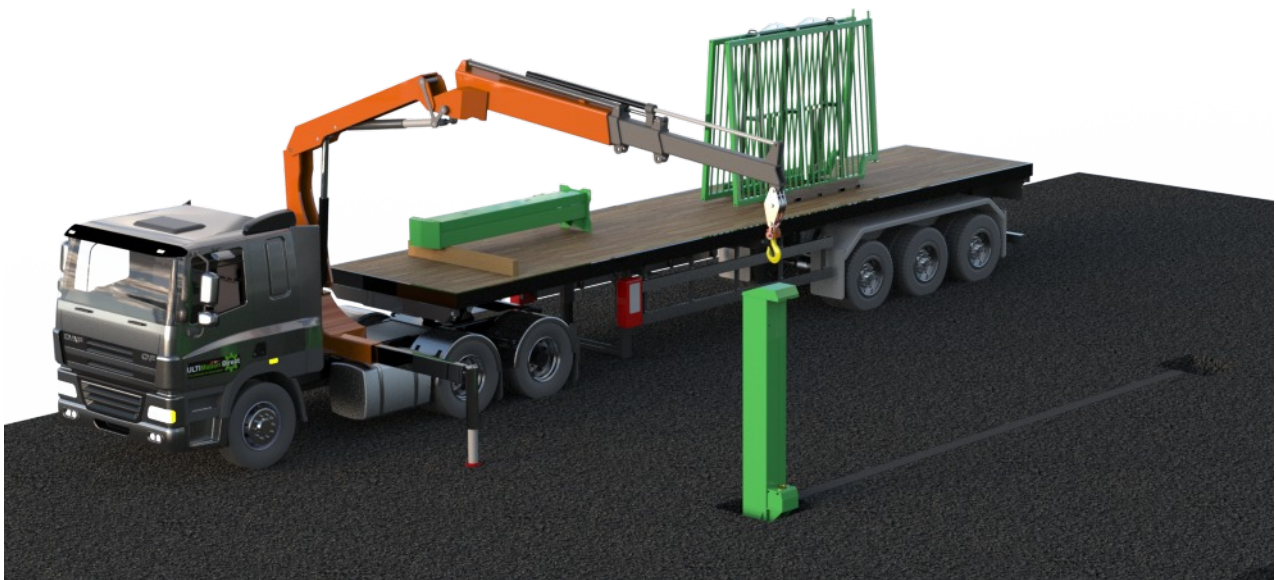

Shown below is a general layout of a typical pair of D6000I gates

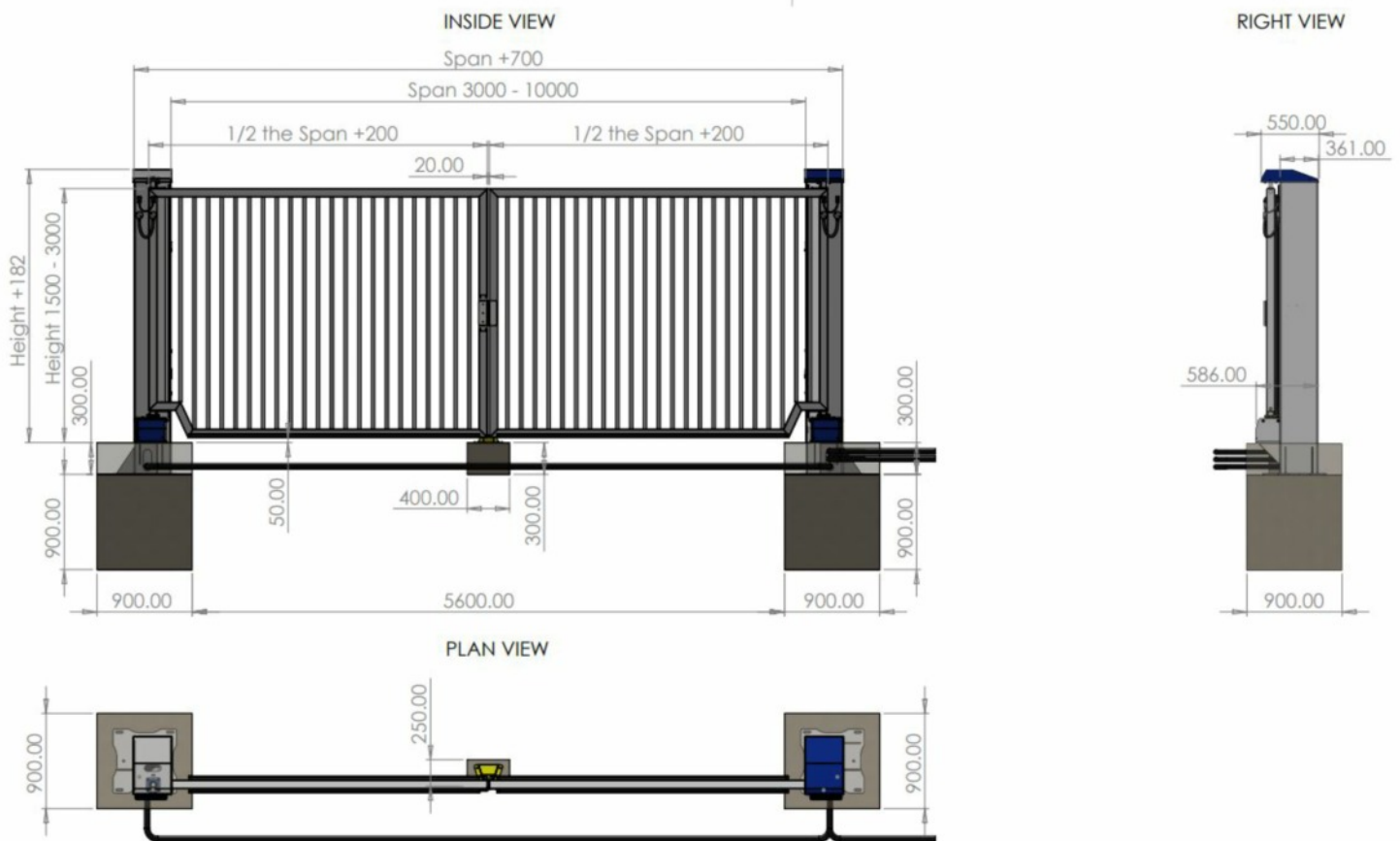

General Description,

The D6000I Swing gates are designed to provide the perfect solution for security in Industrial locations where Reliability and Security is paramount. Commonly chosen for applications such as multi-storey car parks, prison entrances and corporate access roads, they provide an aesthetically pleasing, high security entrance control solution. They are fitted with our reliable heavy duty drive systems which are almost silent in operation and are fitted and within the gate posts. They have an Impeccable service record with maximum longevity in the most demanding Environments. Gates are engineered to allow bolt down fixing to suitable concrete pads, and are compatible with all current access controls.

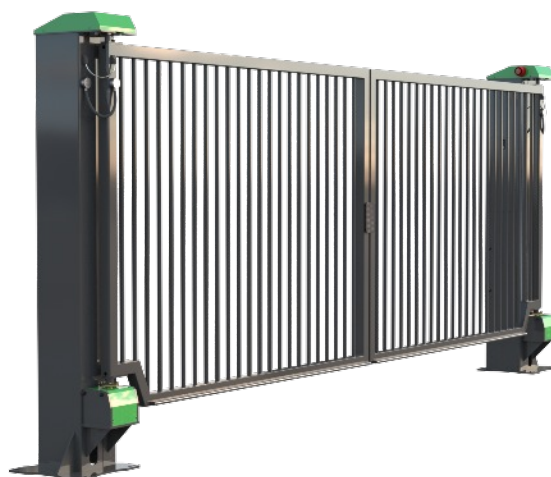



Foundations

All foundations should be installed as per drawing supplied as base size's will vary depending on the size of the gates. (Contact your supplier if you have not been issued one.) All foundations should be installed 10 x days prior to the gates being installed.

If details of the base have not been specified, we recommend a concrete mix to BS EN 206:2013+A2:2021 "Concrete specification, Performance, Production and Conformity" to type C35, which is equally suitable for external and internal environments.

The foundation must be positioned accurately and installed to the correct levels to ensure successful installation.



Careful consideration should be made when deciding the location of the gate to avoid overhead obstructions such as power cables, telephone wires building canopies, trees and other types of likely obstructions and hazards, which will not

Ducting

Ducting carrying cables for power and control should enter the gate support frame from underground. Two ducts are normally required, one for the power supply, the other for the control. Where the power supply and control cables are to come from a common place; a single duct can be used.

These ducts must be sited accurately in the base as shown on the contract drawing. The use of cable access pits is recommended where there may be a number of ducts used entering the gate or long cable runs are necessary. We also recommend the ducts used be of 100mm diameter PVC. Alternative types and sizes may be acceptable, subject to discussions with your equipment supplier.

Slow bends should always be used wherever possible, and the inclusion of draw ropes throughout the ducting system, will ensure that the cables are easily installed.

Single Leaf Bits Box;

1. Manual winder
2. 8 x m16 x 180mm through bolts
3. 8 x m16 caps
4. Keys
5. 4 x m10 x 25mm Hex bolts
6. 4 x m10 washers
7. O&M Manual

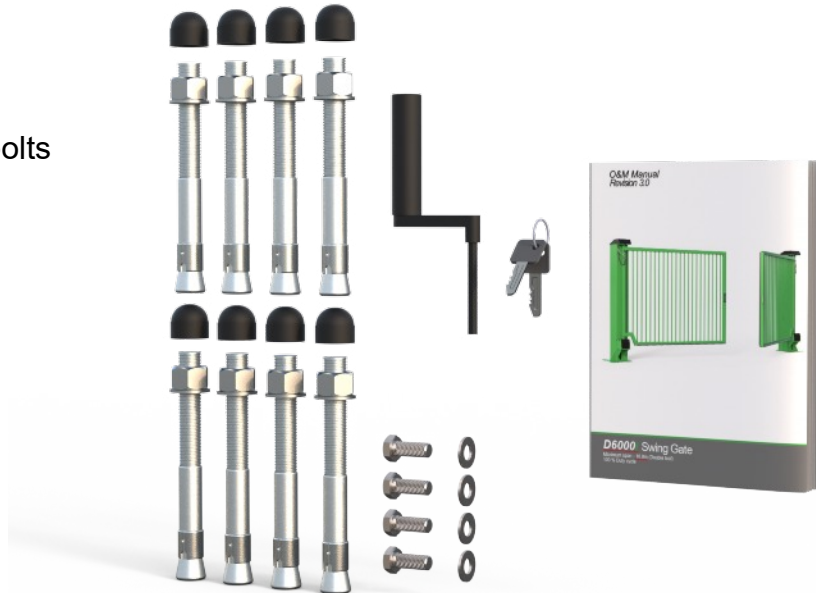
**Double Leaf Bits Box;**

- | | |
|--|---|
| <ol style="list-style-type: none"> 1. 8 x m16 x 180mm through bolts 2. 8 x m16 caps 3. 2 x keys 4. 4 x m12 x 125mm thorough bolts 5. 4 x m12 caps | <ol style="list-style-type: none"> 6. 2 x keys 7. 2 x Manual winders 8. O&M Manual 9. Floor Ramp 10. 8 x m10 x 25mm Hex bolts 11. 8 x m10 washers |
|--|---|



Step 1, Bolting down

Once you have the first post/gate located on the Foundation with crane still strapped you must Align the post centrally with the opposite base And drill and fix one bolt in allowing you to Unstrap the crane and prepare to lift the other post into position.

Note; M16 bolts must be tightened to 85nm of torque.

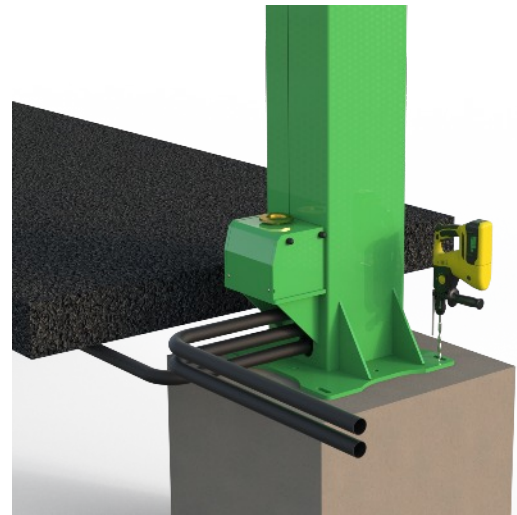

Step 2, Aligning the gates and setting distance

Now you have the second post you can align the posts up with the help of a string line to ensure both posts are in the correct position. A tape or range finder will also help to ensure the gap between posts is correct as specified by the drawings. Once this is achieved you are ready to bolt down the first post completely. I would advise leaving the crane attached to the second post at this point



Step 3, Levelling post 1

Now post one has all bolts installed good practice would be to level this post up as slight alterations can affect the distances between posts. Levelling should always be done using metal shims or packers suitable for the weight of the gate.

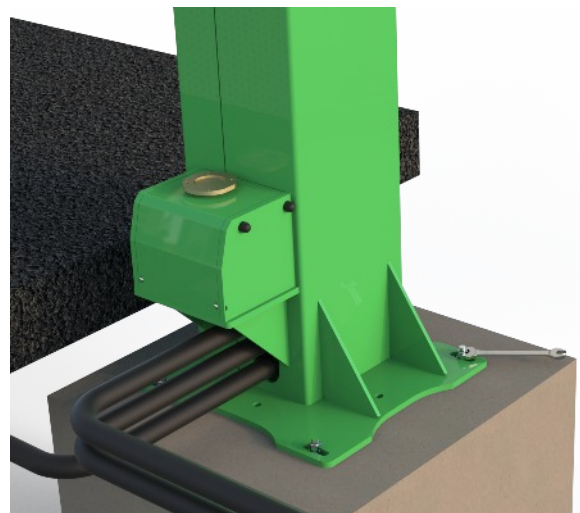

Step 4, Post alignment

Now the first post is in and level it is suggested to recheck the string line and distance between posts. Once you have achieved the correct distance and alignment post 2 can be fully bolted down and levelled

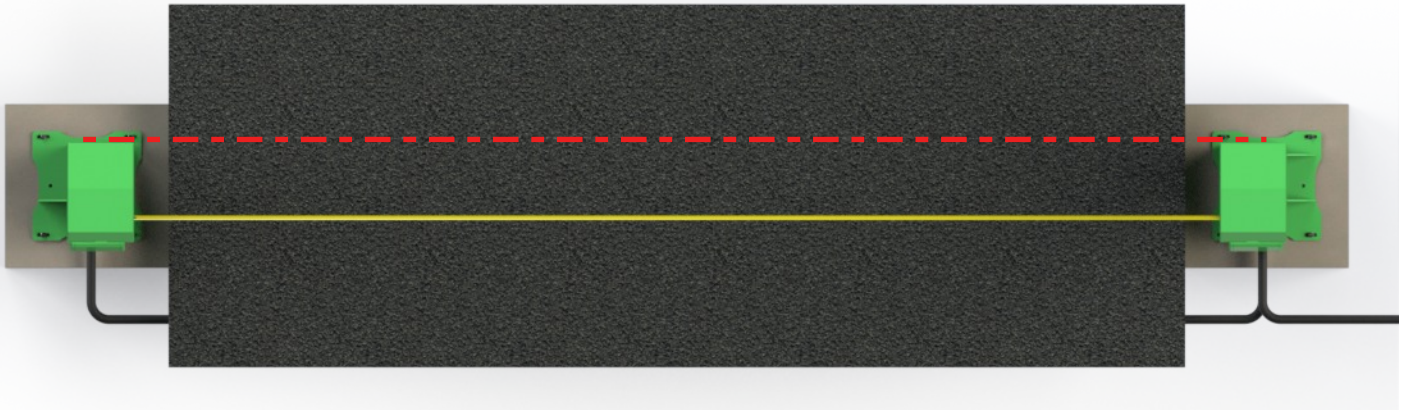

Step 5. Hanging the gates.

Now both posts are installed and secured the gates can be hung and installed onto the posts. First remove the top lid on both posts, Then remove the bolts out of the top hinge bearing to allow you to drop the gate frame onto the bottom hinge. See Fig 7

Fig 7

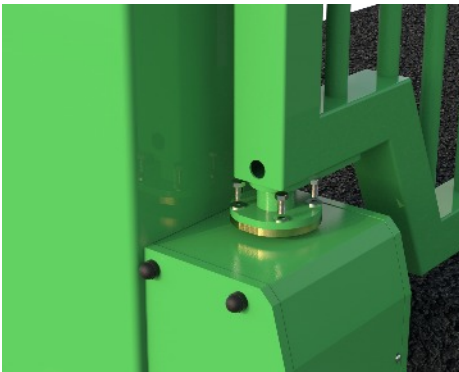

Once you have the bottom Hinge located, Using an 17mm Spanner/Socket tighten the M10 x 20 Bolts up. Then place the top hinge bearing onto the top gate shaft, See Fig 8. Now re-install the M14 x 50 Bolts back into place and ensure they are fully tightened using a 22mm spanner or socket. See Fig 9

Fig 8

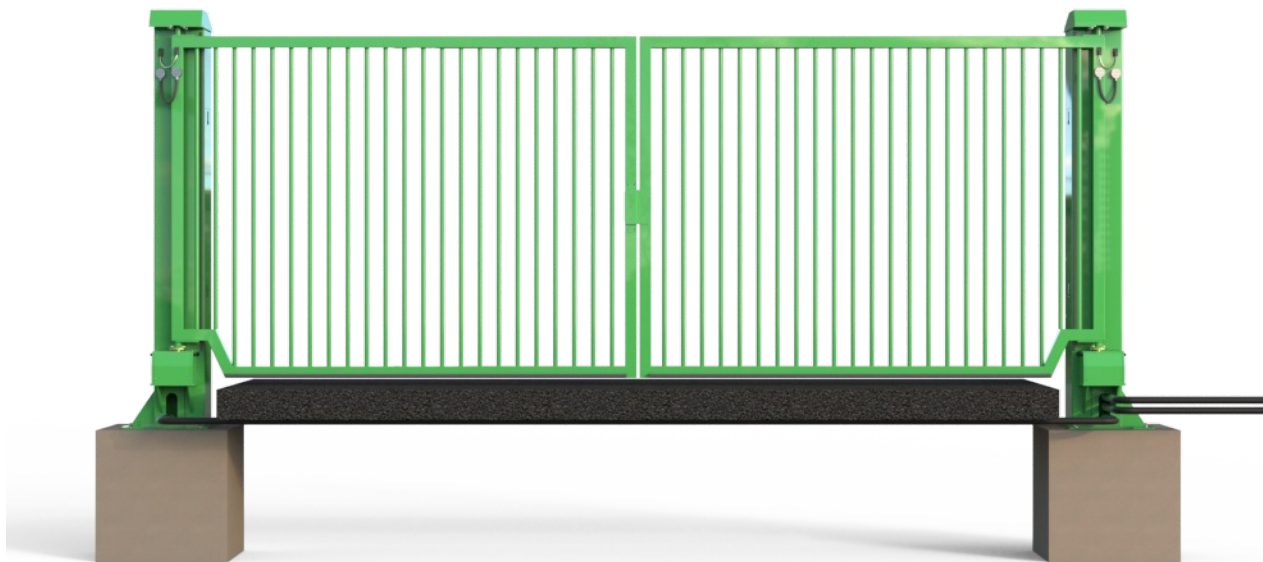

Fig 9



Step 6, Checking Alignment

Now both gates frames have been hung you need to operate the gates manually into the fully closed position to check for alignment. At this stage you have adjustment on the base plate slots to be able to move the posts closer or further apart. If you need to do this make sure you have the Crane connected back on the gate for support.



Step 7, Fitting the Door loops/U Safe's

Both the Door loops and the U Safe's come fitted to the gate frames from the factory, So now the gate is hung you will need to connect these onto the posts. To connect the U safe you will need to insert the U safe into the 15mm hole in the post and tighten with a 5mm allen key, a small impact wrench is always advisable for these fixings.



To connect the Door loops Feed the cables down the post and into the control panel, Then screw the end of the door loop into the galv conduit box, This can be tightened using a 24mm spanner. One gate frame will have an open and closing edge cable ready at the door loop and the other gate frame will have an Opening and closing safety edge Plus the Maglock cable. See below.



Step 8, Central floor ramp

Now the gates are fully aligned and bolted the central floor ramp can be positioned and installed. A suggestion would be to open and close the gates manually to ensure correct positioning of the floor ramp and smooth operation of the gates.

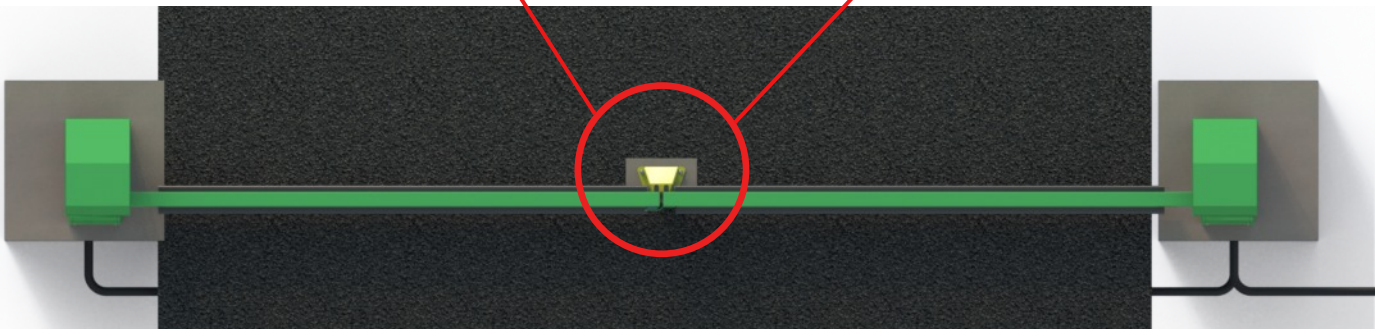
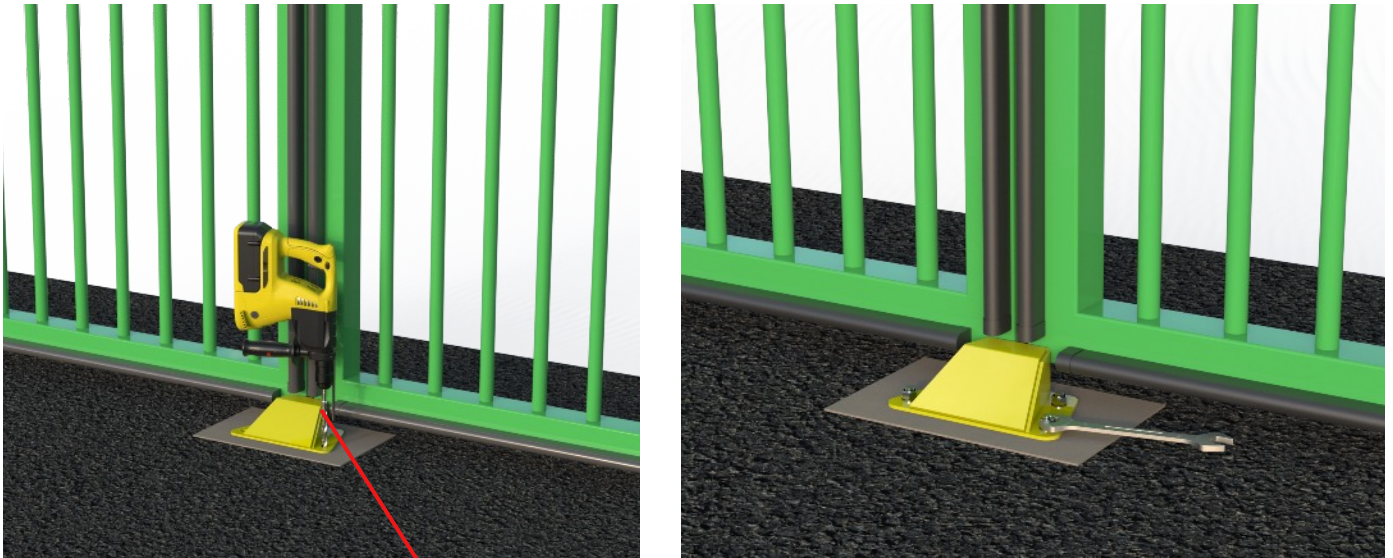

Step 9, Back filling

Once the posts are fully bolted and all cables installed and tested the posts can now be back filled. This requires c35 grade concrete as it forms part of the structural integrity of the posts.

Note; If gates are surface mounted this step does not apply.

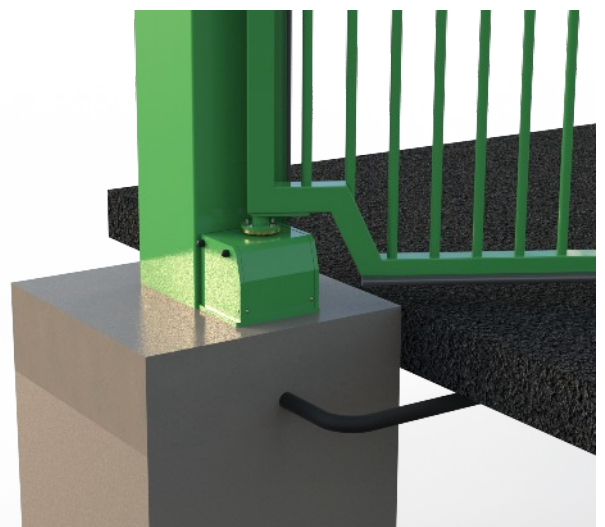

Single Leaf;

Please note if single leaf the gate will come with a closing post complete with maglock and photocells if requested, details of wiring can be found in the following pages, the same previous steps can be followed to install your closing post however a brief guide is shown in detail below.

Single Leaf closing post;

The post can be drilled using the specified 16mm drill bit and suitable sds drill. Please note the ducting will need locating into the lower inspection hole.



Single Leaf closing post cont;

The anchor fixings can be installed and the post levelled in the same way as previously mentioned, it is mainly the aesthetics and connections that will alter. In the case of back filling please feed enough cable to be accessed via the higher inspection cover for wiring ease and future use.

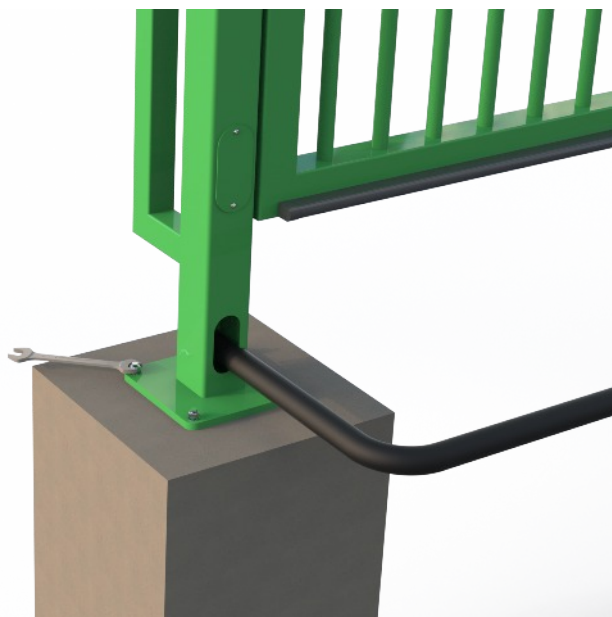



Mains Instalation,

Now the posts and leaves are fully installed you can begin the wiring process of the gates if this is single leaf follow this step then the next page for photocell wiring. For double leaf it will be this step only for both posts with the addition of three cores to each master/slave module details of which can be found in the following pages on the board terminal lists for master/slave



Mains Isolator

Connect the mains into the three phase rotary isolator found in post/s under the panel. This is a 230v single phase 16amp supply required.

Connecting The Photocells.

Please note this is for single leaf installations. On double leaf the cells will communicate via the data link between posts

Note; The photocells are pre wired into two separate channels which allows us to wire both receivers into the gate stanchion and series the photocell contacts into the board before dispatch from our workshop. This in tern makes installation easier as you are only required to send 24v across to the closing post to power the transmitters.

Note; The Higher photocells are switched to channel 2 by the pink from the receiver and the black cable from the transmitter wired into the positive supply.

To Connect the photocells Please remove the cover plate from rear of the closing post by undoing the 2 x m6 bolts this will require a 4mm Alan key.

Once removed you will find 2 x wagos ready to connect your 24v too, This can be achieved by connecting the positive 24v into the wago containing the 2 x brown and 1 x black wires, And the negative 24v into the wago containing the blue wires. Back at the stanchion this will just be a case of connecting in to the auxiliary 24v supply from our terminal blocks, 12 being positive 24v and 13 being negative 24v. Please see following page.

The Diagram below shows the Photocell wiring In the closing post, This is pre-wired in the factory Along with the maglock connections. See the below Diagram for connecting into the Master post.

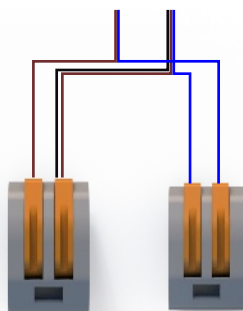

Please note the internal photocell is pre wired to Channel two via the black being added with the Positive connection

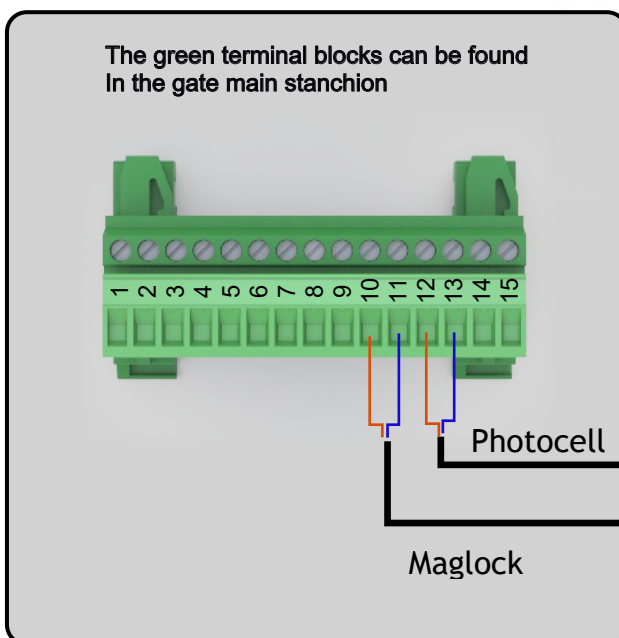

The green terminal blocks can be found In the gate main stanchion



- 86 Common +24v dc
- 85 Open Dead Man
- 84
- 83 Common +24v dc
- 82 Close Dead Man
- 81
- 76 Common
- 75 Photocell
- 74 Ground -24v dc
- 73 Common +24v dc
- 72 Pedestrian Open (Common from 73 if used)
- 71 Ground -24v dc (Common for opening edge)
- 66 Beacon Sounder (common from 71)
- 65 Open Edge 8k2 Input (common from 71)
- 64
- 63 Ground -24v dc
- 62 Common +24v dc
- 61
- 54 Close Input
- 53 Stop Input (link from 51 if not used)
- 52 Open input
- 51 Common +24v
- 45
- 44 Ground -24v (Common for Close Edge)
- 43 Close Edge Input (Common from 44)
- 42 Common +24v dc
- 41 Stop Input (Link from 42 if not used)
- 36 Ground
- 35 Channel B
- 34 Channel A
- 33 +12v
- 32 Common +24v dc
- 31 Stop input (Link from 32 if not used)
- 22
- 21 +24v dc Link from power supply if mag requested
- 20 Maglock Positive feed
- 12 Green Traffic Light +24v dc
- 11 +24v dc Link
- 10 Red Traffic Light +24v dc

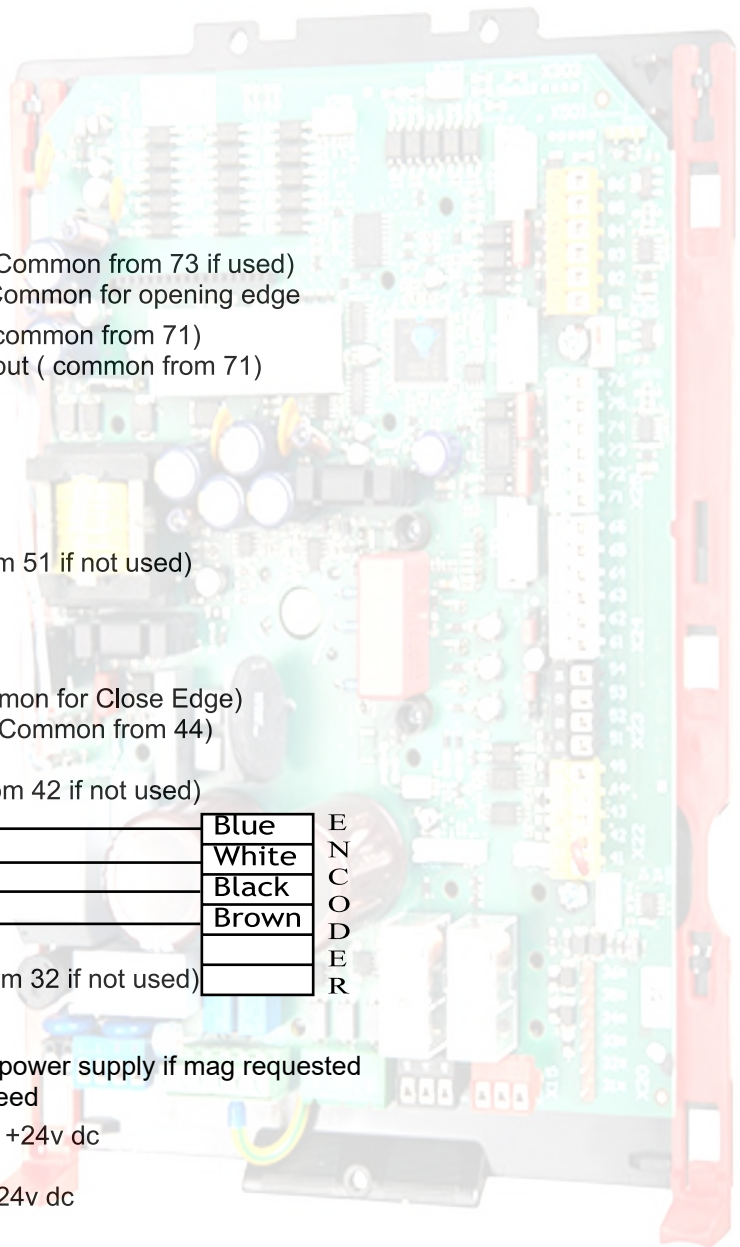

36	Ground	Blue	E
35	Channel B	White	N
34	Channel A	Black	C
33	+12v	Brown	O
32	Common +24v dc		D
31	Stop input (Link from 32 if not used)		E
			R

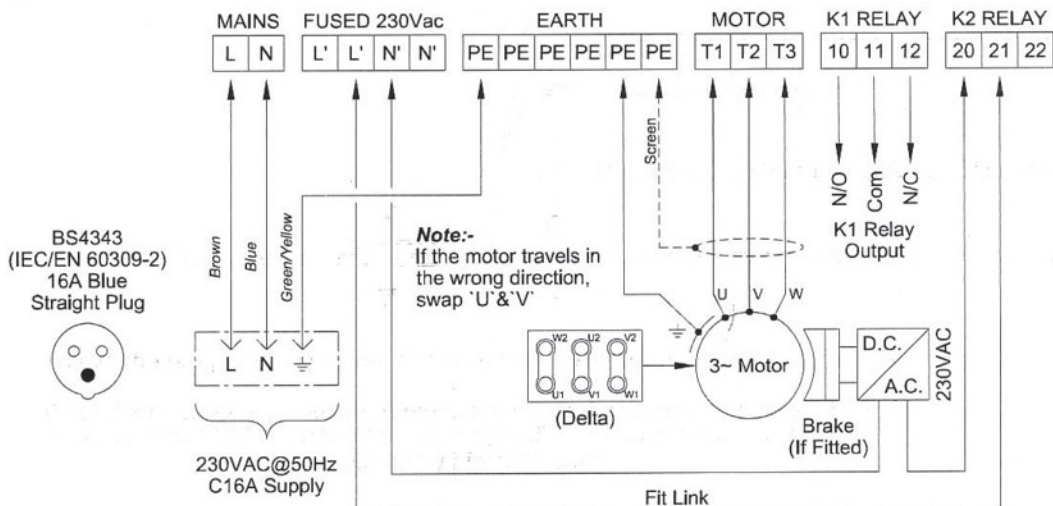

- 86 Common +24v dc
- 85 Open Dead Man
- 84
- 83 Common +24v dc
- 82 Close Dead Man
- 81

- 76 Common
- 75 Photocell
- 74 Ground -24v dc
- 73 Common +24v dc
- 72 Pedestrian Open (Common from 73 if used)
- 71 Ground -24v dc (Common for opening edge)

- 66 Beacon Sounder (common from 71)
- 65 Open Edge 8k2 Input (common from 71)
- 64
- 63 Ground -24v dc
- 62 Common +24v dc
- 61

- 54 Close Input
- 53 Stop Input (link from 51 if not used)
- 52 Open input
- 51 Common +24v

- 45
- 44 Ground -24v (Common for Close Edge)
- 43 Close Edge Input (Common from 44)
- 42 Common +24v dc
- 41 Stop Input (Link from 42 if not used)

- | | | | |
|----|---------------------------------------|-------|---|
| 36 | Ground | Blue | E |
| 35 | Channel B | White | N |
| 34 | Channel A | Black | C |
| 33 | +12v | Brown | O |
| 32 | Common +24v dc | | D |
| 31 | Stop input (Link from 32 if not used) | | E |
| | | | R |

- 22
 - 21
 - 20
- Slave Connect To terminals 41 And 42

- 12 Green Traffic Light +24v dc
- 11 +24v dc Link
- 10 Red Traffic Light +24v dc

Master 2 core From relay 2 20 and 21

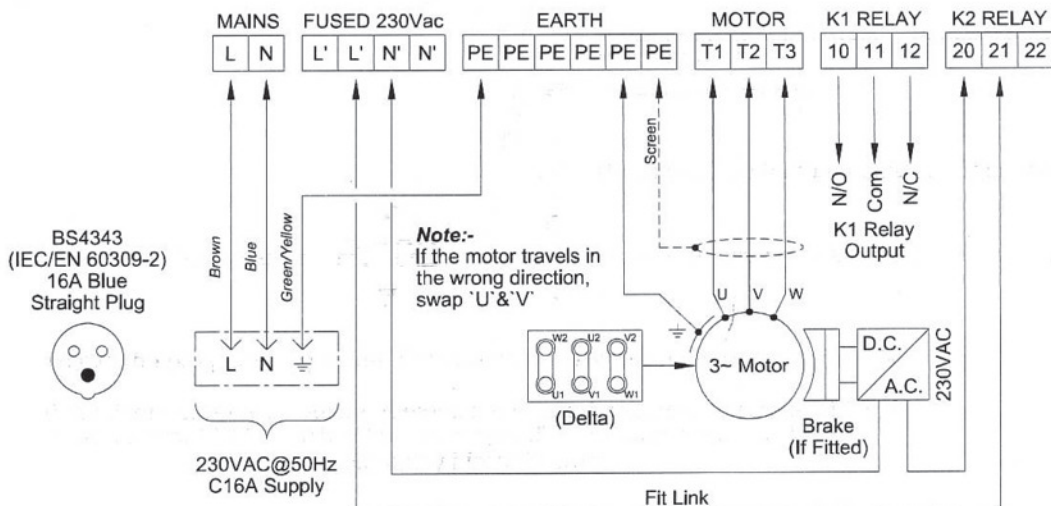
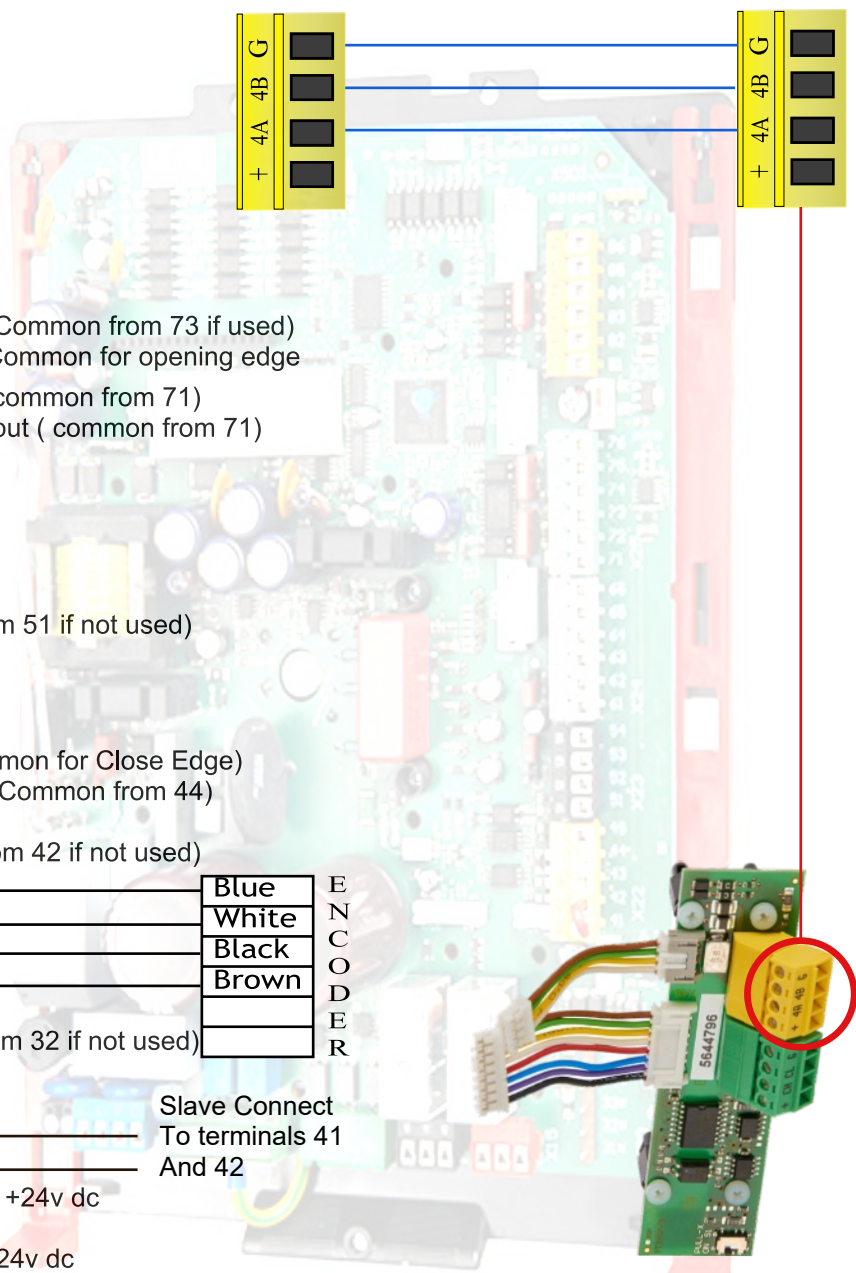

- A. Loop Channel 1
- A. Loop Channel 1
- B. Loop Channel 2
- B. Loop Channel 2
- 1. Common +24v dc
- 2. Stop N/C
- 3. Open N/O
- 4. Close N/O
- 5. Open Edge
- 6. Open Edge
- 7. Close Edge
- 8. Close Edge
- 9. Free
- 10. Maglock 24v dc +
- 11. Maglock 24v dc -
- 12. +24v dc (For slave photocells)
- 13. -24v dc (For slave photocells)
- 14. Photocell common (yellow)
- 15. Photocell contact (Grey)

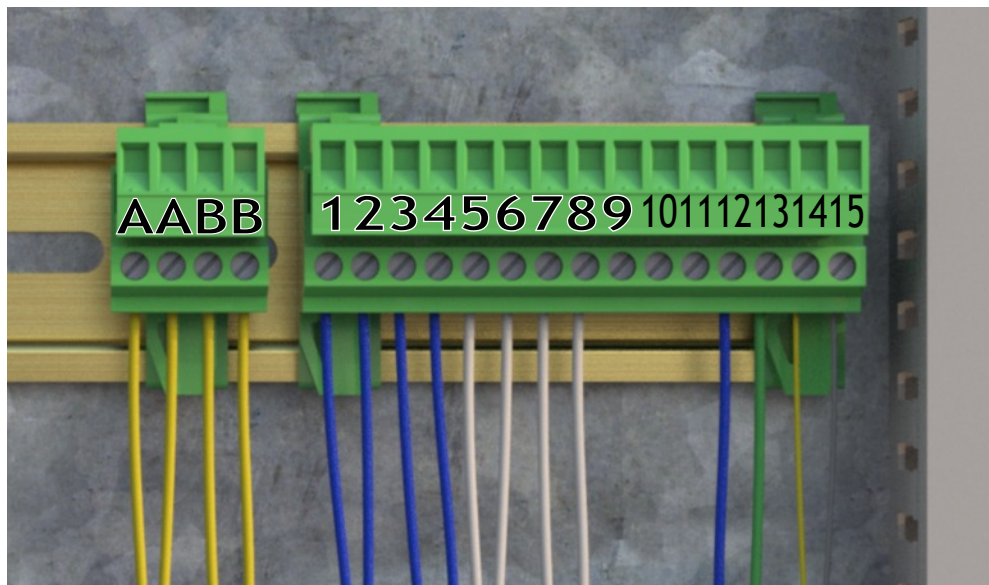

Safety and Auto loop bases

We now use the feig plug in loop cards for convenience of the engineer. If ordered with the product this will arrive with tails pre wired into the green terminal strip.

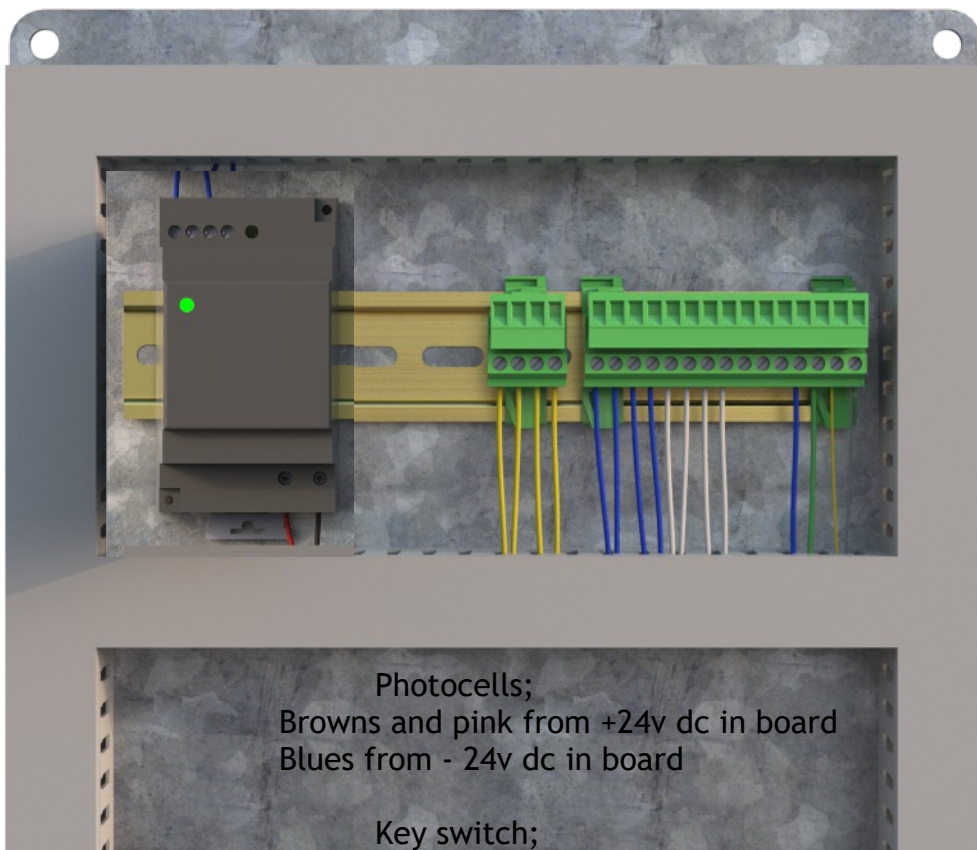

Photocells;
 Browns and pink from +24v dc in board
 Blues from - 24v dc in board

Key switch;
 From deadman open/close in board

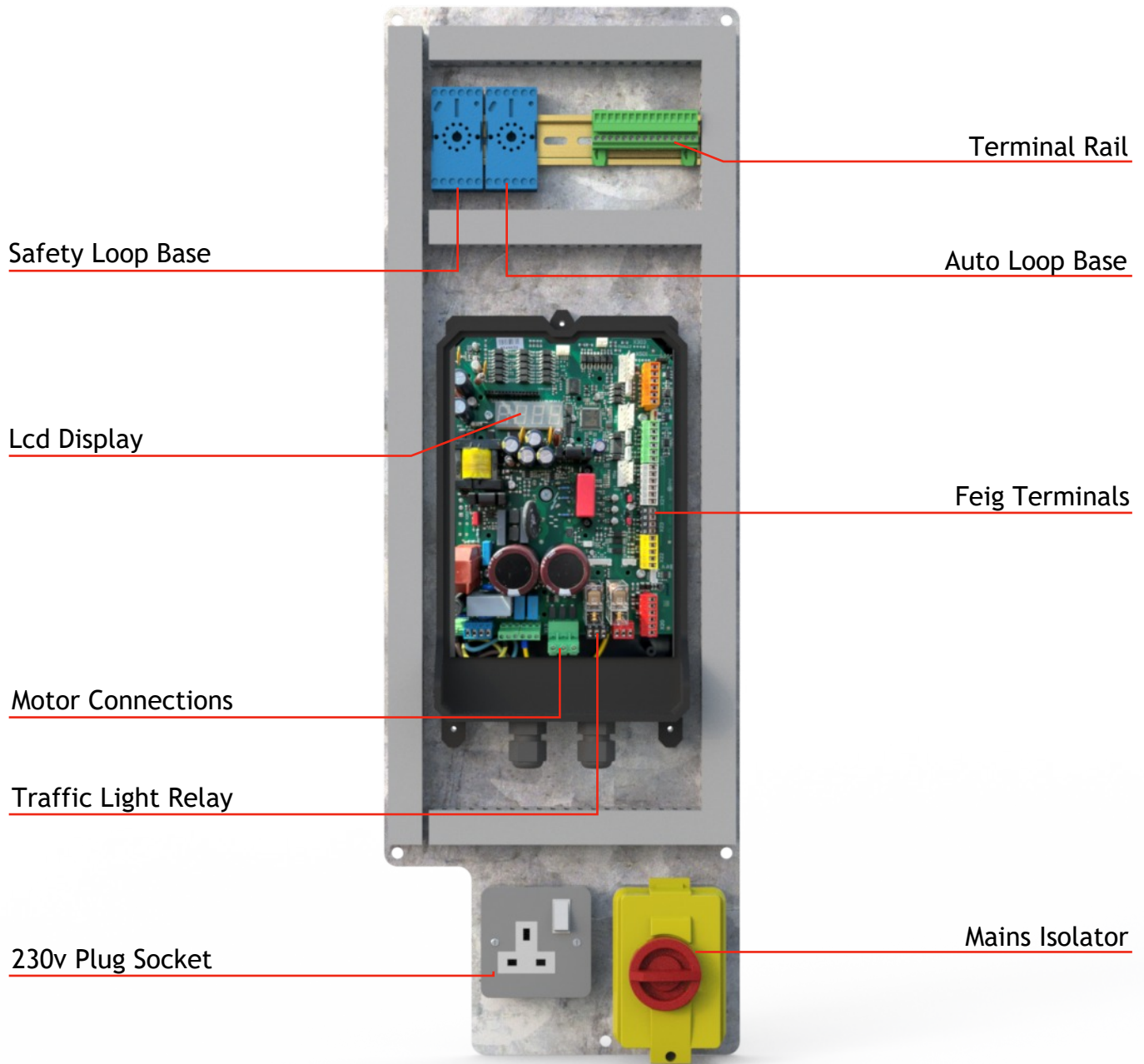

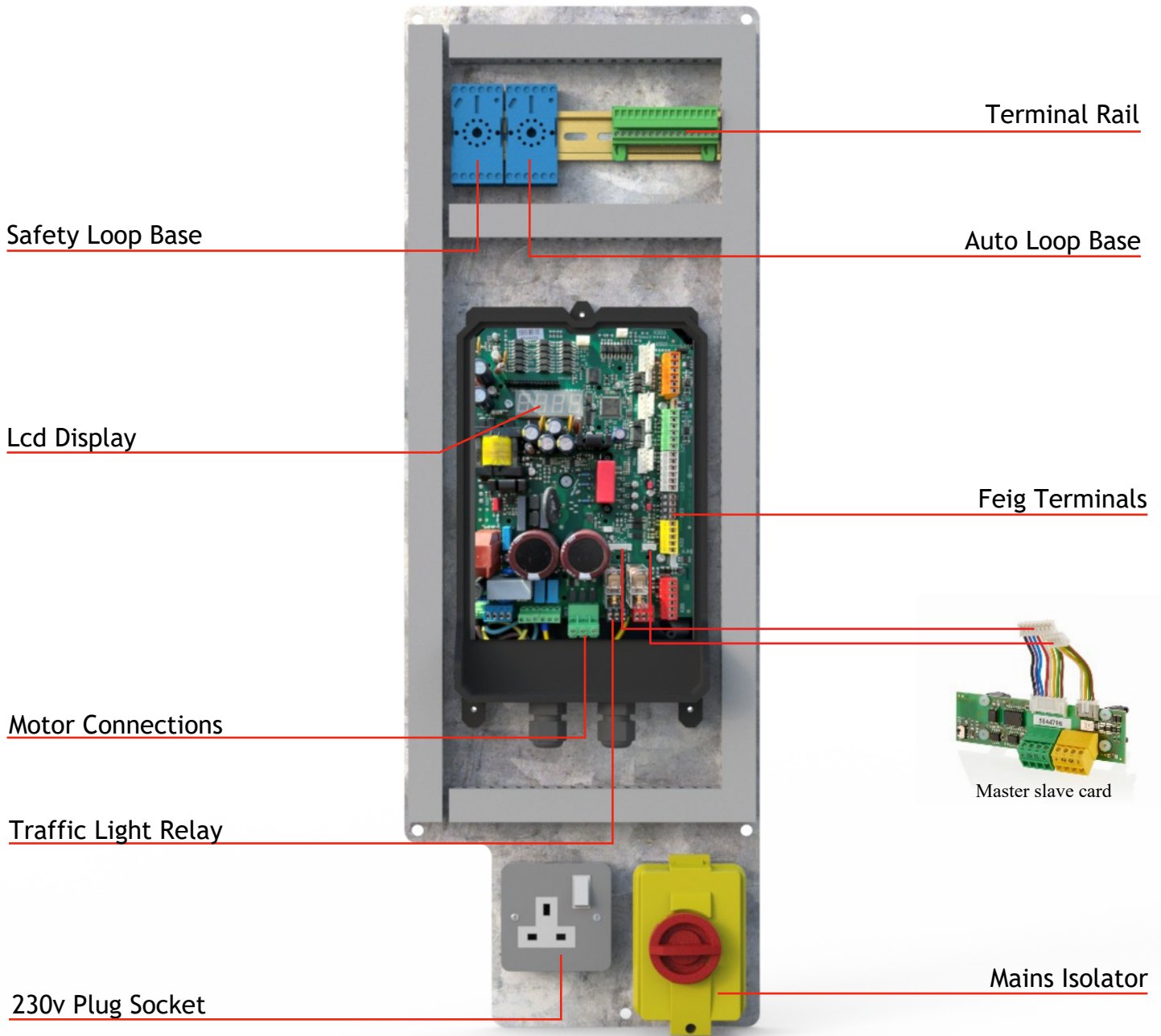

24vdc PSU (Maglock)

Terminal Rail

Lcd Display

Feig Terminals

Motor Connections

Master/Slave Card

Traffic Light Relay

Mains Isolator

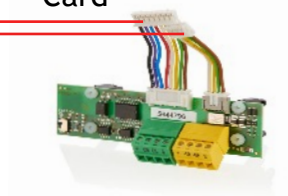
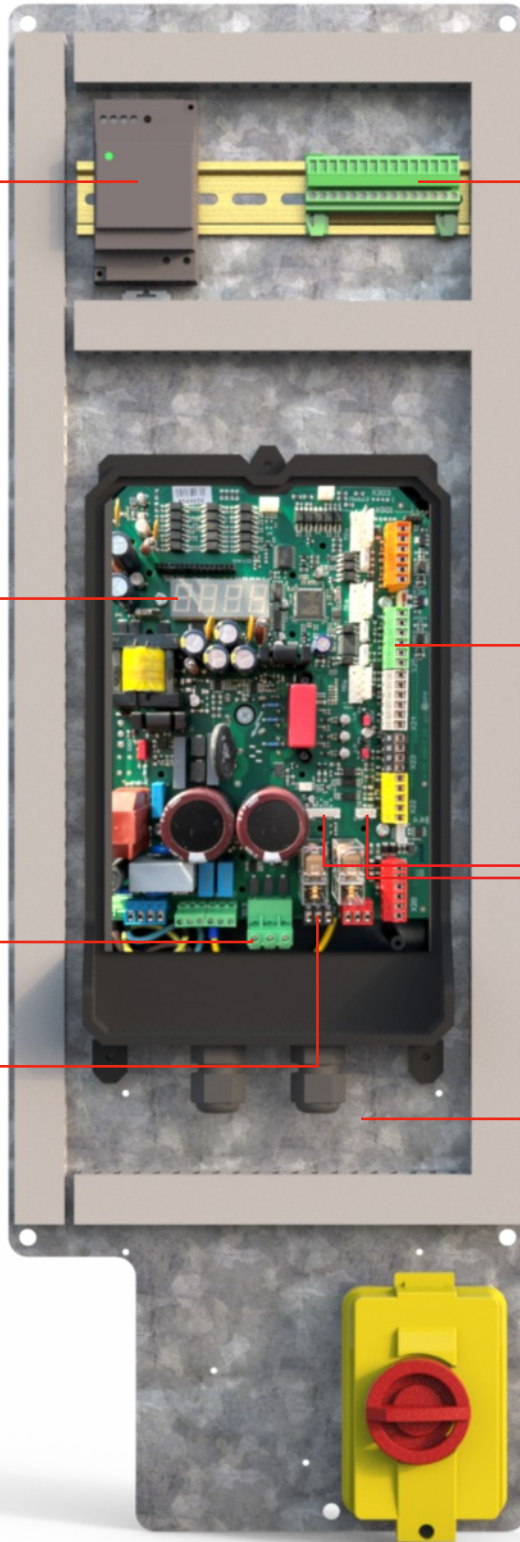

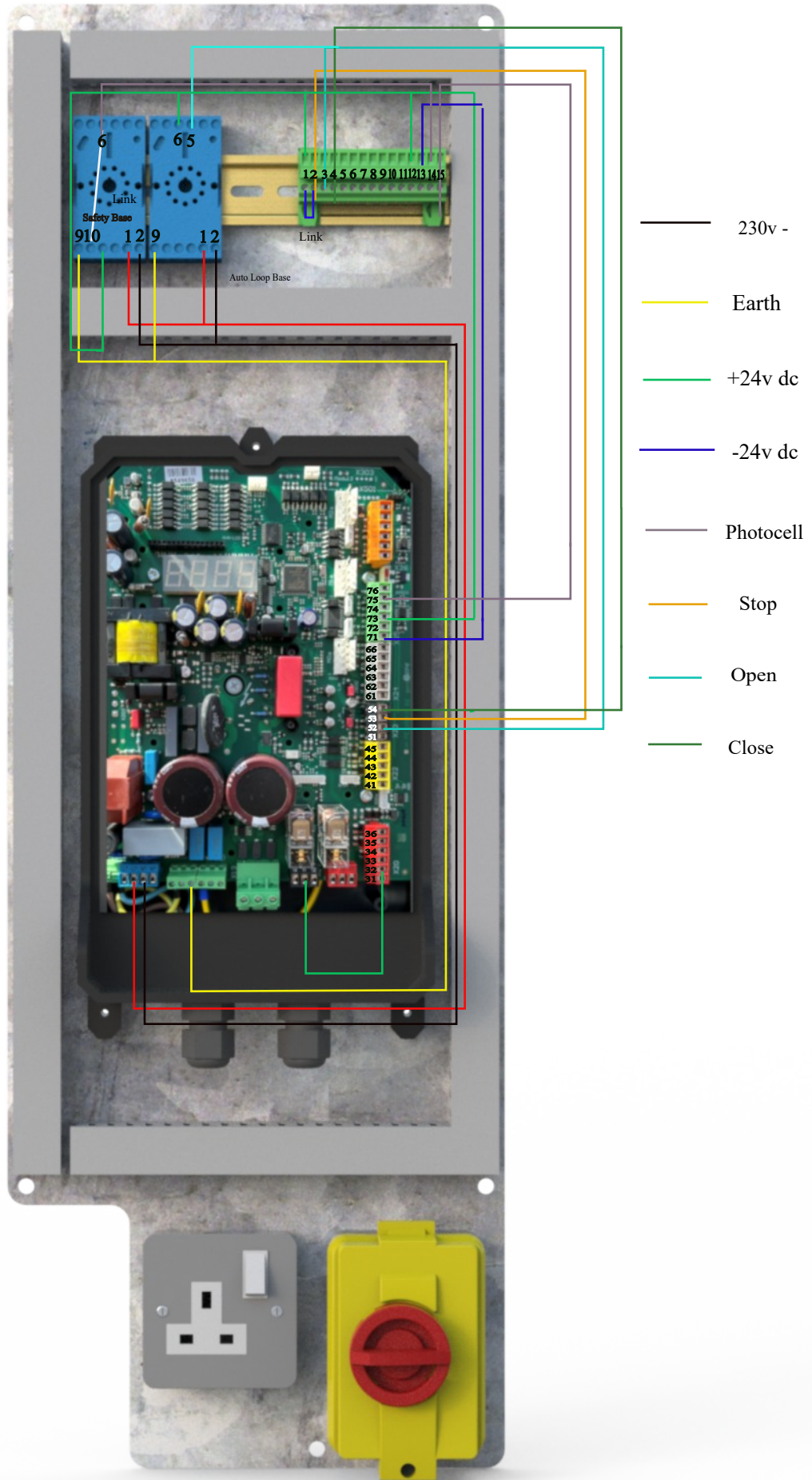

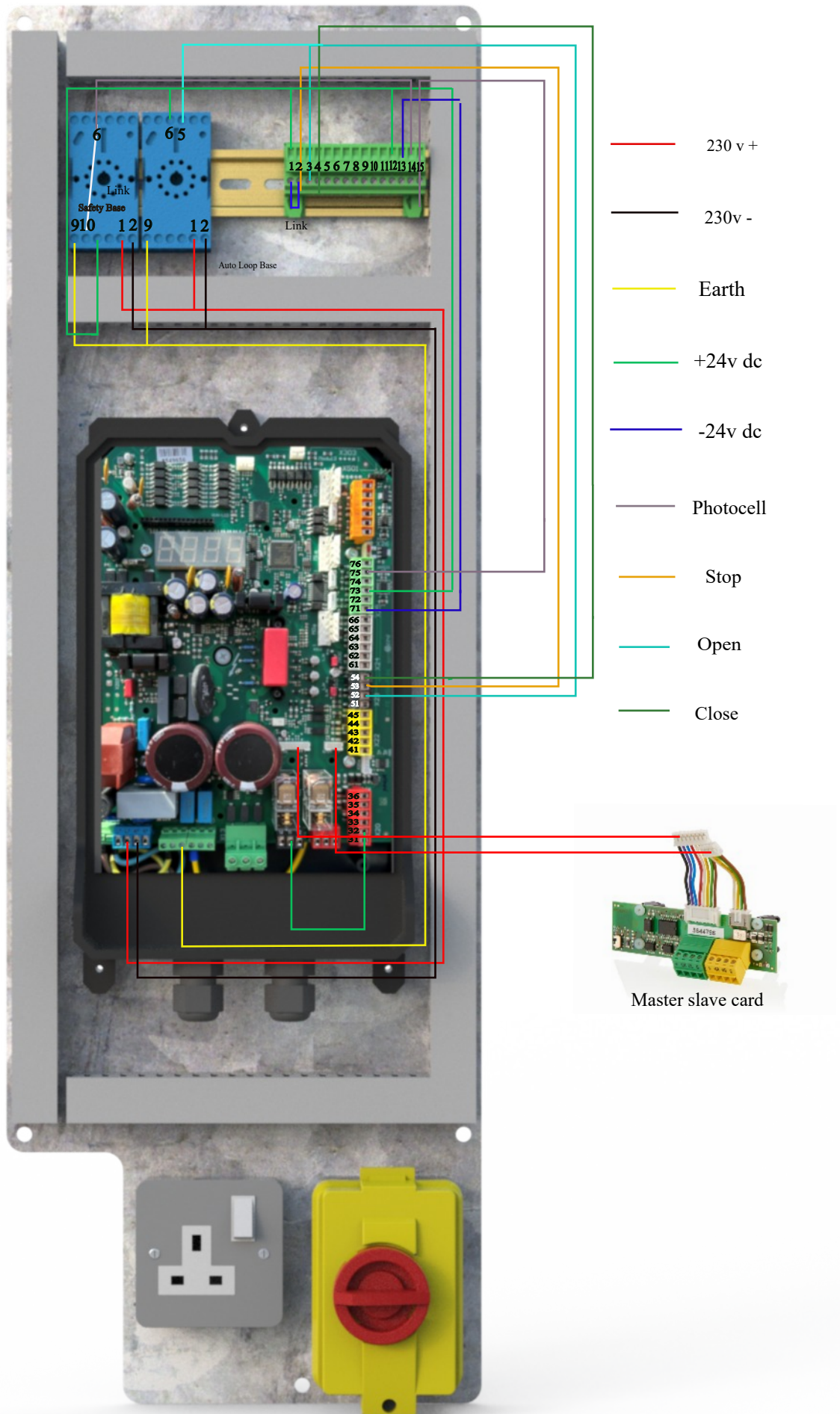

- 230 v +
- 230v -
- Earth
- +24v dc
- -24v dc
- Photocell
- Stop
- Open
- Close

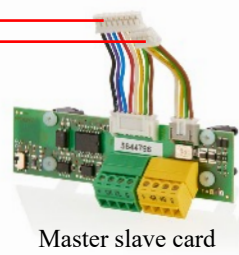

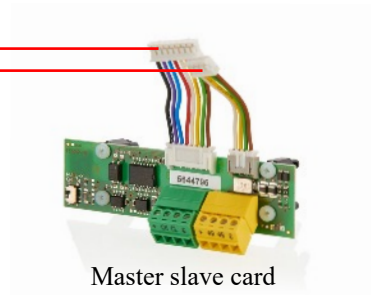
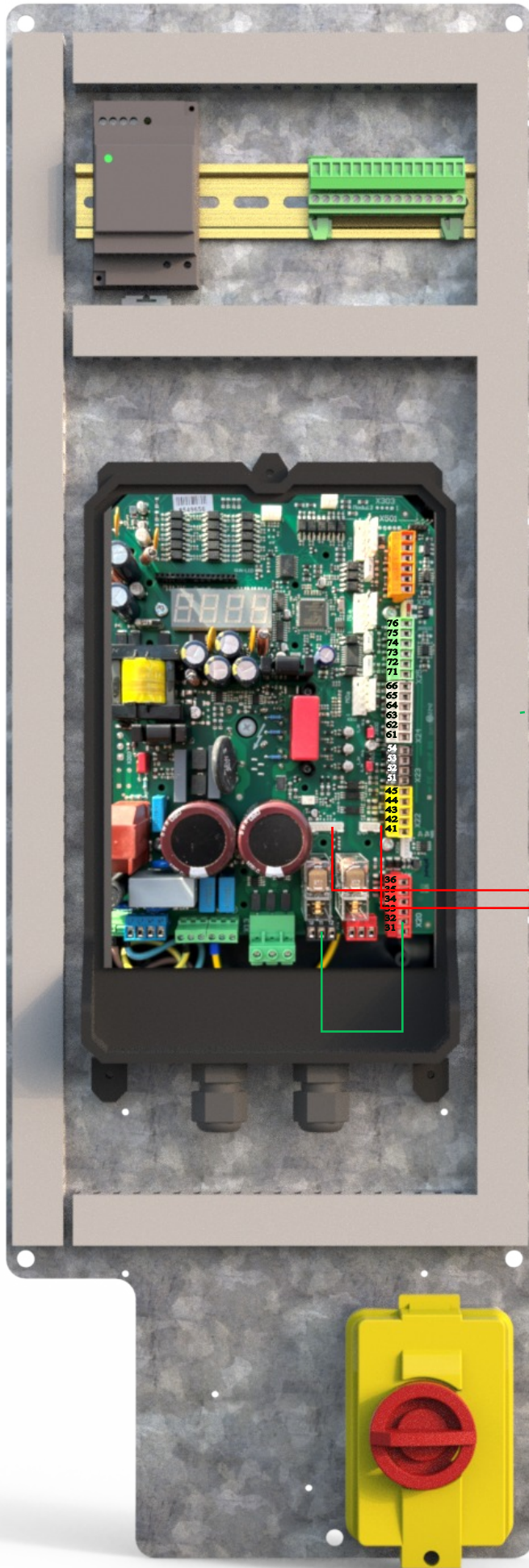

Master slave card

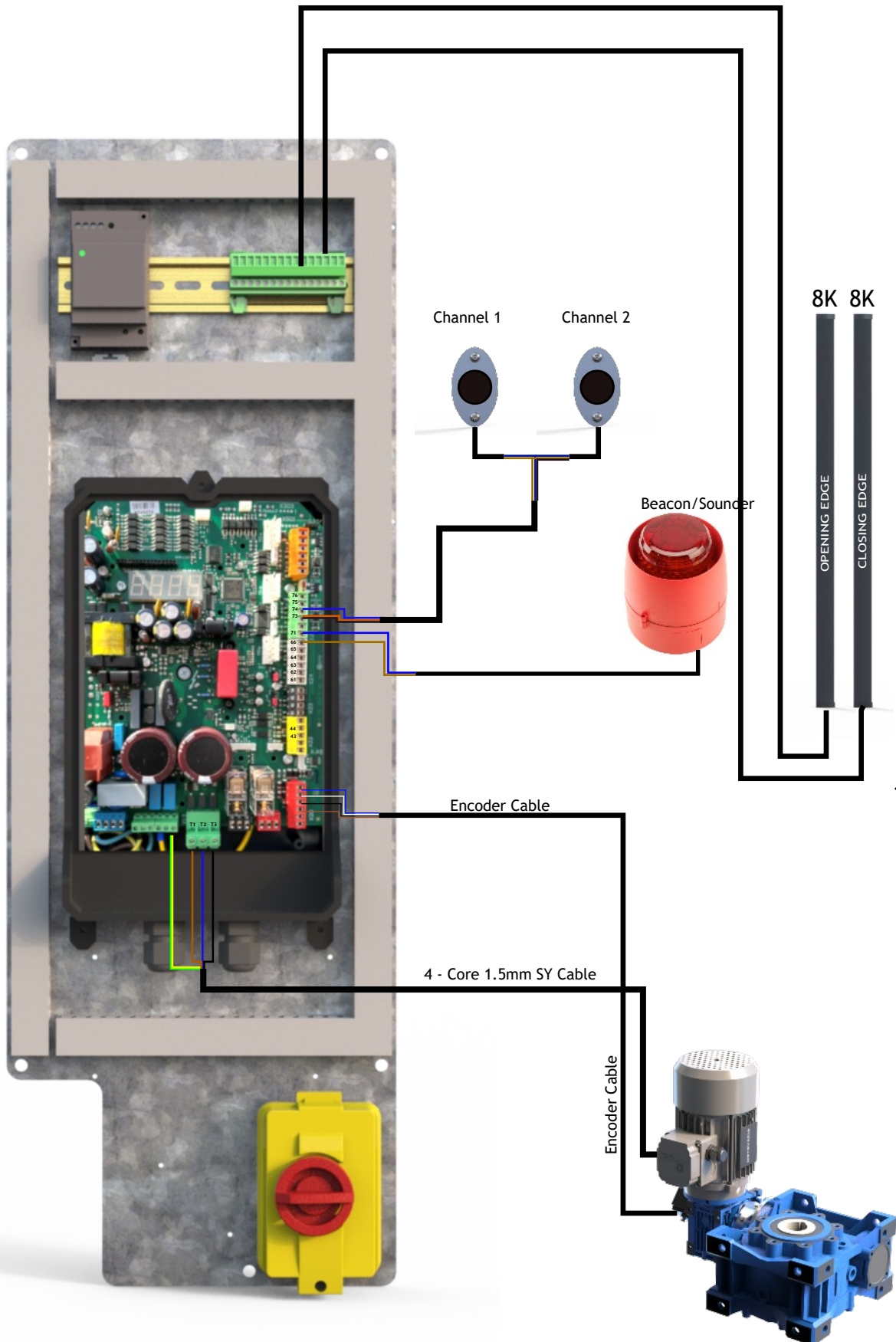

When you have the gate powered and ready to run please follow the next few steps to initially set up your encoder run positions. This will only need setting once.

Figure 1

Step 1;

Set up with the encoder is very similar however you do not need to replicate any limits. Once powered up provided there are no faults the board will display the message Cali, this is asking you to calibrate the encoder. Figure 1



Step 2;

When ready press the stop button briefly. The board will now display The EI-EC asking you to sync to close position. Note the dots between the letters will be flashing.

Figure 3

Step 3;

Simply hold the down arrow to close the gate to its desired position, don't worry if you let go early simply press the down to jog the gate to position. Once at your desired close position press and hold the stop until the dots stop flashing this will record the close position and then revert to the open sync, Figure 4



Step 4;

Please now using the up arrow move the gate to its desired open position. Again once happy press and hold the stop button until the dots stop flashing to store the open position.



Step 5;

The gate is now set and ready to operate, before testing safeties I would advise at this point to give the gate an open and close operation to ensure the positions are correct and you can see the slow downs and ramps operating correctly.



Step 6,

If you are now happy with the gates positions please test all safeties as normal, i. e all edges and photocells. The gate also now incorporates a force detection this will require a firm push to the leaf to enable its operation whilst the leaf is travelling. The leaf once force detected will move to its opposite position and stop. If The gate positions need resetting please follow the following few steps to re calibrate the encoders.

Step 7,

Should we need to reset the positions on the gate please follow these steps.

You will need to access the parameters menu. This can be done by pressing and holding the stop and up arrows together. See figure 6

Figure 6

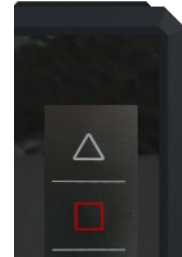
**Step 8,**

Navigate through the menu to parameter 999 (figure 7) using the up arrows. (Note holding the down arrow and pressing the up will move through parameters in blocks of ten for ease)

Figure 7

**Step 9,**

Once at P999 press and the stop button this will enter the parameter allowing you to change the value. Please set this to number 3 using the up arrows and confirm by holding the stop again for 2 seconds. Figures 8 and 9) to exit the parameter just press the stop key.

Figure 8

**Step 10,**

Now navigate through the menu to parameter 210 and set this to 5, this will reset the encoder allowing you to re calibrate the gate. Please follow previous steps until you are happy with the positions and safeties.

Note This setup is the same for single leaf and master and slave. The buttons will only work the leaf to which they are installed. To test both leaves on a bi parting gate, (double leaf) please use the open and close inputs on the board.

To set the timers on the feig board follow the instructions to access the full parameters menu by accessing P999 and setting to 3, The timers can then be adjusted as follows to suit sites requirements. Please note with timers and parameters, setting them to the 0 position will turn the timer off.

Parameter	Description	Timers
P010	No Passage Timer	30
P020	Open Delay Timer	0
P025	Close Delay Timer	0
P712	Traffic Light Delay	0

Customisable parameters. Bellow is a list of parameters and functions that are offered with the control board, please note the feig controller does not have a built in time clock. These can be supplied on request and programmed to suit site requirements.

Parameter	Description	Values
P000	Cycle Counter	Full Gate Cycle
P005	Maintenance Counter	Counter Set Between Service Periods
P920	Error Log	Last 8 Errors
P925	Software Version	Current Software Version
P985	Language	0 = English
P232	Open Slow Down	In Increments Of Travel
P222	Close Slow Down	In Increments Of Travel
P582	Normally Closed Limits	0 = On 1 = Off

The loop board can be added to your Feig controller as per the diagram these simply push in for ease and allow easy control for single or dual channel.

L.E.D Indications
 Green fast flash - Detector Tuning
 Green Solid Light - Detector is ready
 Green and Red on - Loop detecting
 Red Solid Light - Loop Fault

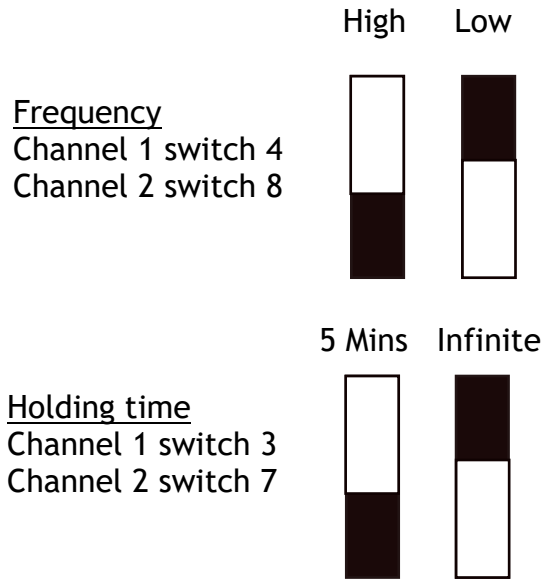
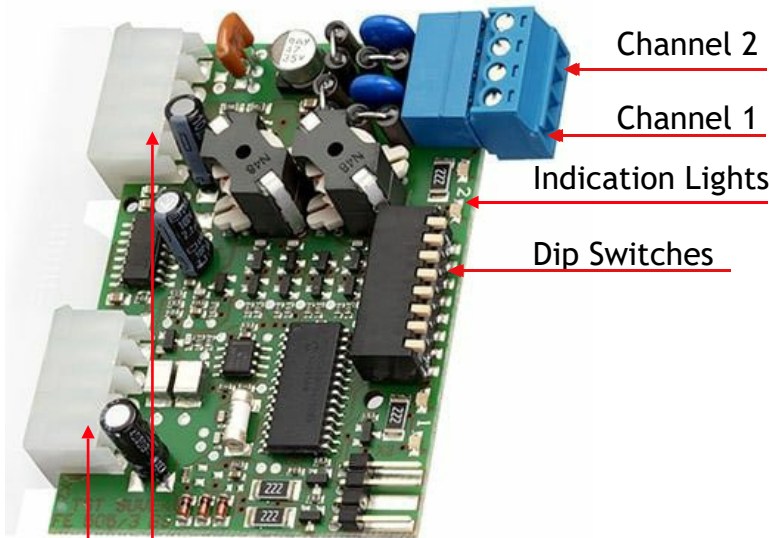

Dip switches 1 and 2 for sensitivity loop 1
 Switches 5 and 6 loop 2

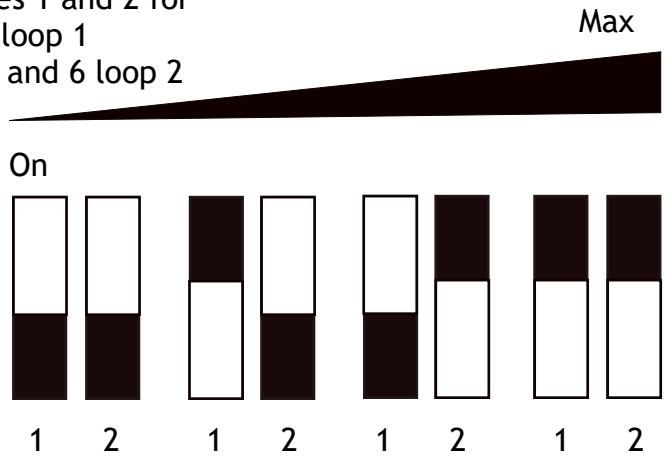

The loop card when used must be activated this is done by changing up to three parameters on the feig controller depending on the application and functionality of the loops to be installed.

- P.802 - 0302 This activates the loop card.
- P.660 Channel 1 -
- P.670 Channel 2 -
- 23 This activates the safety function of the loop card.
- 22 This activates the free exit (open signal) from the loop card.
- 20 Turns the parameter off

If master slave or double leaf the 660 and 670 parameter will need changing on both panels.

In the event of a power failure or fault on the gates you can manually release the gates as described below.

Please use the following instructions to operate the gates manually, the following is assuming you have powered down the control panel.

The drive motor is located inside the gate post at the bottom. To manually release you will need to remove the lower door using the provided keys.

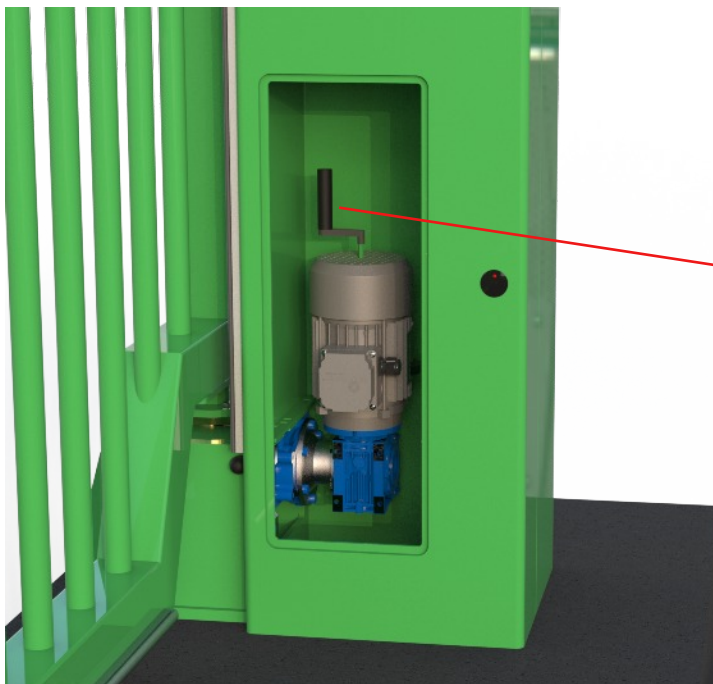
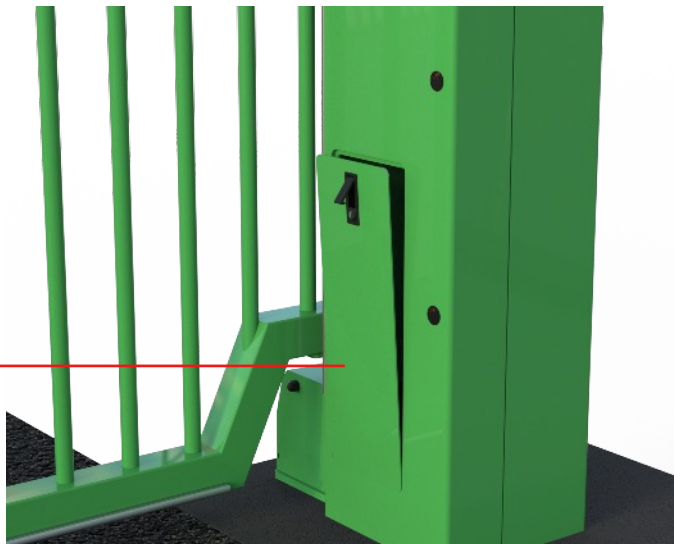

Simply insert the manual winder into the button head on top of the motor and wind as desired to open and close the gates

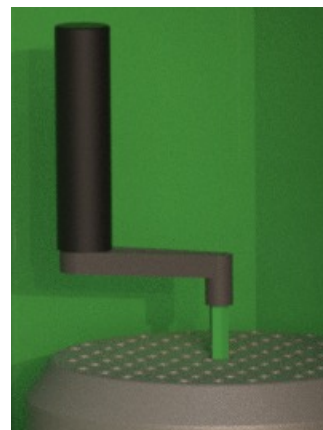

When in manual mode be sure to operate the gate carefully as damage can be caused if gates are slammed open and closed. You must make sure the gates are tied back if left in manual mode to prevent the gates moving on there own.

Warning

Make sure the power is disconnected to prevent any sudden movement on the motors that may cause injury.

Also take great care when operating manually in windy conditions.



As stated at the beginning of this manual we recommend a bi-annual service, but at a bare minimum, it is imperative that you get a service done once every 12 months. This is not a sales tactic in disguise, there is a very serious health and safety issue/risk associated with not complying to this. Also in order for your gate to keep complying with the appropriate legislation.

Before carrying out any maintenance to the installation, disconnect the mains power supply.

Make sure you have disconnected/isolated the power before attempting any work.

A Maintenance Contract should be sought from a specialist company after a maximum of 5000 manoeuvres or 1 year from the install date.

Occasionally clean the photocell optical components and make sure they are free from dirt, water, rain, soil etc.. ? Batteries in photo cells may need to be changed every 6 months or sooner dependant on use. The gate will not work properly without photo cell function.

If the power supply cable is damaged, it must be replaced by the manufacturer or its technical assistance service, or else by a suitably qualified person, in order to prevent any risk.

When any operational malfunction is found, and not resolved, disconnect the mains power supply and request the assistance of a qualified technician (installer). When automation is out of order, activate the manual release to allow the opening and closing operations to be carried out manually.

Gearbox drive unit is "sealed" for life and requires no further lubrication.

Parts that require lubrication -

The double leaves have 4 x Bearing hinges on them that require lubrication, Single leaves are just 2, they have a grease nipples located at the side. The Bearings can be found Under the gearbox and on top of the main post.

On a annual service these items mentioned above should be lubricated as well as all other checks listed below.

Checks on a service -

- All safety edges are operational
- All photocells are operational
- Encoder is operating correctly
- Gates are structurally ok e.g no damage
- All connections/wiring are ok
- All push buttons and stop circuits operate correctly

Your Gate will conform to BS EN 12453:2017+A1:2021 the standard for powered machinery and any additional amendments to this critical safety standard. We manufacture gates and equip them with safety and other options, only to the extent specified by our customers. Therefore, the gates, as delivered, may not represent a complete machine as defined by the regulations. As such, the addition of any after market safety devices by the client must conform to this standard as well as BS EN 12978:2003+A1:2021 the standard for sensitive safety devices. The three main points of covered in this standard are the installation, design and elimination of hazards and electrical control system integrity also the Implementation of devices designed for safe contact (force limitation) such as resistive safety edges. The standard also covers Non Contact (presence detection that prevents hazardous contact) such as and not limited to, photocells, light curtains, radar sensors and inductive loops.

It is imperative that the installer carries out an onsite risk assessment prior to fitting or maintaining the gates, and a residual risk assessment once the installation is complete. These will highlight any remaining safety issues, and allow the installer to fit additional equipment or draft suitable protocols for operation of the equipment. Therefore the product must be installed and maintained by a competent, qualified and well trained company or individual.

As standards are ever improving the safety devices and systems in use may need to be upgraded from time to time. The standards will always refer to 'state of the art' safety devices being used in conjunction with the product. However the emphasis is always preferred on non contact devices with the back up of sensitive (force detecting products also).

To add additional safety products and accessories to an existing product the relevant paperwork and Declaration of incorporation (or Certificate of Compliance as appropriate) must be updated and kept for the relevant standards to be adhered to.

All Electrical supplies to gates and machine products must be installed to the correct Standard i.e. the current edition of BS 7671:2018+A3:2024 and any alterations to this supply must be recorded and adhere to this standard. These can be recorded in the Electrical installation Certificate or the Periodic Inspection report.

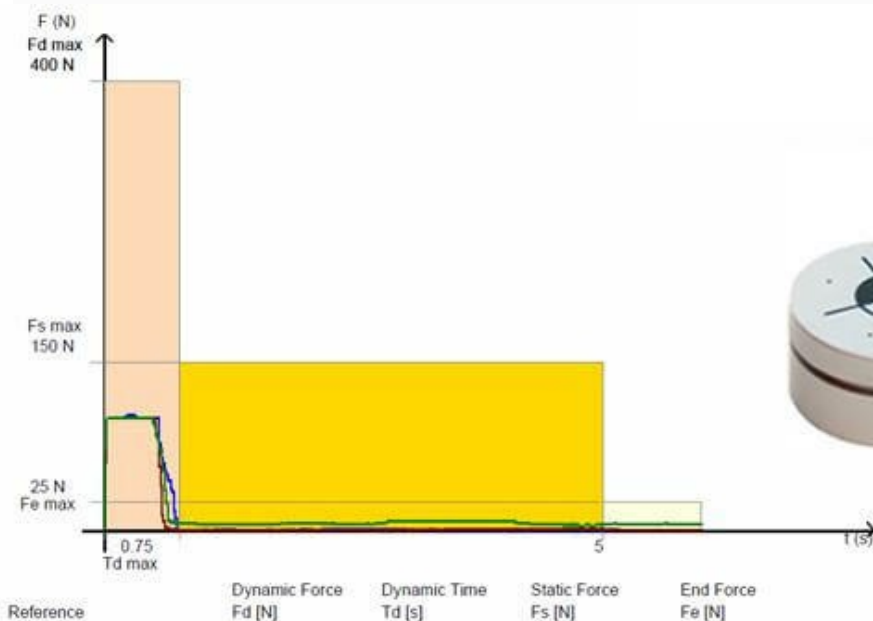

Code	Description	Reason
E000	Open pressed Membrane	
E050	Stop pressed Membrane	
E090	Close pressed Membrane	
E101	Open input	Open activated
E102	Stop input	Stop activated
E103	Close input	Close activated
E104	Ped open Input	Ped activated
E105	Photocell input	Photocell activated
E106	Dead open input	Deadman open activated
E107	Dead close input	Deadman close activated
E108	Open limit input	Open limit activated
E109	Close limit input	Close limit activated
E110	Input 10	Open safety input loss of 8k
E201	Membrane stop pressed	
E211	E-stop	Terminals 41/42 open
E212	E-stop	Terminals 31/32 open
E360	Close edge input	Terminals 43/44 open
E363	Close edge resistance	Terminals 43/44 no 8k
E380	Open edge input	Terminals 63/65 open
E383	Open edge resistance	Terminals 63/65 no 8k
E501	Loop detector channel 1	Channel 1 active
E502	Loop detector channel 2	Channel 2 active

Code	Description	Fault / Rectification
F000	Traveled Past calibrated open	Check Speeds/ Encoder Slip / Re-calibrate
F005	Traveled Past Calibrated open	Check Speeds/ Encoder slip / Re-calibrate
F020	Run Time exceeded	Check P410/P415/P419
F030	Lag Error	Check Boost settings P.140 / P.145
F031	Moving wrong direction	Channel A/B reversed. Recalibrate p210
F211	E-Stop	Terminals 41/42
F212	E-Stop	Terminals 31/32
F325	Obstacle During Closing	Adjust force detection settings
F360	Closing edge activated	Edge detected terminals 43/44
F363	Interruption closing edge	Check for 8k input
F380	Open edge activated	Edge detected terminal 63/65
F383	Interruption open edge	Check for 8k input
F425	Overvoltage Supply	Incoming mains voltage too high
F426	Undervoltage Supply	Incoming mains voltage too low
F430	Heat sink temp out	Power stage too high
F515	Motor Overcurrent	Boost settings too high, P140/P145
F700	Position Unknown	Cali not set or recalibrate P210 to 5
F752	Loss of Comms with Encoder	Interface cable defective/No 12v supply
F766	Encoder Error	Re-calibrate P210-5
F76A	Encoder Magnetic Field	Re-fit magnet further into encoder
F7A2	Expansion Board error	Loss of coms master/slave
F930	External watchdog error	Moisture on board / Hardware error

We certify that the system covered by this certificate has been commissioned satisfactorily.			
Site Name		Completion	
Site Reference		Engineers Installing	
Installation Commenced	/ /	Commissioning	
Equipment Fitted			
Handover Date			

Part 2. Existing Installation Items not covered under warranty/ This certificate:

--	--	--	--

Part 3. Certificate Signing off

Installers Name		Signature	
On Behalf of		Date of Signing	
Address		Position	
Client Name		Signature	
On Behalf of		Date of Signing	
Site Address		Position	

Part 4. Onsite training for product usage

Trainers Name,	Date	Competency / Job Title	Signature
Attendees Name	Date	Signature to confirm understanding	



This Manual **must** be completed in accordance with the guidelines below, **at any point** service/repair work is carried out on the product. This is to achieve two things;

1. To keep a history of the product for yourself and your supplier/manufacturer.
2. To keep an accurate log of any historical or recent modifications, and/or problems, to help an engineer in the event of any future work required on the product.
3. This page is continued on the next page if extra space is needed.

Date	Reason for visit/Action taken	Engineers Signature
/ /20		
/ /20		
/ /20		
/ /20		
/ /20		
/ /20		
/ /20		
/ /20		
/ /20		
/ /20		
/ /20		
/ /20		
/ /20		
/ /20		
/ /20		
/ /20		
/ /20		



Ultimation Direct Ltd
Maltkiln Lane, Newark, Notts, NG24 1HN

Tel: 01636 550300
Email: enquiries@ultimationdirect.co.uk

Declaration of Conformity

In accordance with BS EN ISO/IEC 17050-1:2010

We: Ultimation Direct Ltd

Of: Trent Lane, Maltkiln lane, Newark, Notts NG24 1HN In

accordance with the following directives:-

Supply of Machinery (Safety) Regulations 2008

Electromagnetic Compatibility Regulations 2016

The Radio Equipment Regulations 2017

Hereby declare that:

Equipment: Automated Swing Gates

Model no: D6000i

Are in conformity with the applicable requirements of the following documents:

Supply of Machinery (Safety) Regulations 2008.

BS EN 12453:2017+A1:2021 Industrial, commercial and garage doors and gates—Safety in use of power operated doors— Requirements.

BS EN 12604:2017 Industrial, commercial and garage doors and gates—Mechanical aspects—Requirements and test methods.

BS EN 13241:2003+A2:2016 Industrial, commercial and garage doors and gates - Product standard. Products without fire resistance or smoke control characteristics.

BS-EN12978:2003 Industrial, commercial and garage doors and gates. Safety devices for power operated doors and gates. Requirements and test methods.

BS EN 13856-2:2013 Safety of machinery. Pressure sensitive protective devices. General principles for the design and testing of pressure sensitive edges and pressure sensitive bars.

I hereby declare that the equipment named above has been designed to comply with the relevant sections of the above referenced specifications. The unit complies with all applicable Essential Requirements of the Regulations.

Signed:

A handwritten signature in black ink, appearing to read 'Matthew Mulholland', is written over a horizontal line.

Name: Matthew Mulholland

Position: Technical Director

Place: Newark

Date: March 2026

The UKCA logo consists of the letters 'UK' stacked above the letters 'CA' in a bold, black, sans-serif font.

Specification

Maximum Gate Length: 10.0 metres
 Power Requirement: 230v, Single Phase, 50Hz, 16 Amps
 Drive Motor: 3 Phase motor & wormed gearbox
 Opening/Closing time: 8 - 10 seconds (variable)
 Duty Cycle: 100% continuous duty rating
 Finish: Oxy primed and painted in selimix direct

Control: Push-button Open and close - Photocell/safety edges for safety. Dead man keyswitch on the Control panel

D6000 Motor/gearbox

Combined Worm=PAM NMRV/NMRV Power / 040/075 / Ratio (i1xi2)=750(25x30)
 Input Dim.=Ø105x14 (IEC 71 B14) / Connection (Worm Wheel-PAM)=Ø18-Ø19
 Hollow Output Shaft Dim.=Ø28 / Execution=PS2 / Mounting Position=U / Output Cover=Standard
 Pos.J / Ral 5010/Ral 5010 Blue
 *** Motor *** Three-Phase / 071 / 4 / 0,37-0,45 kW / S1 / Standard Efficiency
 Regulations=CE / 230/400-265/460 V / 50-60 Hz / Insulation Rating=F / IP56
 Thermal Protectors=3x Thermistors PTC 130°C / Self-Ventilated / Ral 5010 Blue
 Terminal Box=Pos.4 / Supplier=Motovario
 *** Features *** VI-Lubrication=Eni Telium VSF 320
 VI-2nd Red. Lubrication=Eni Telium VSF 320



Made in the UK

